

Calumet Design Guidelines

February 2004



CITY OF CHICAGO
RICHARD M. DALEY, MAYOR

DEPARTMENT OF PLANNING AND DEVELOPMENT
ALICIA MAZUR BERG, COMMISSIONER

Prepared by:
Planning Resources Inc.

In Association with:
Kabbes Engineering, Inc.
Christopher B. Burke Engineering, Ltd.

Table of Contents, Calumet Design Guidelines

PART I – DEVELOPMENT OPPORTUNITIES	Page
Why Locate In The Calumet Industrial Corridor?	1
Large Tracts of Land in Chicago	1
Transportation	1
Financial Incentives	2
Nature as Neighbor	3
Land Use Plan and Design Guidelines.....	3
Public and Private Partners Working Together.....	3
PART II – DESIGN GUIDELINES	Page
Introduction	4
Section I – Environmental Factors	7
Section I (a) – Soils.....	7
Section I (b) – Hydrology	10
Section I (c) – Natural Areas	13
Section I (d) – Permits	13
Section II – Soil Design Considerations	16
Section II (a) – Modification of Soils	16
Section III – Stormwater Management Guidelines	21
Section III (a) – Sites Draining to Combined Sewers, Storm Sewers or Existing Ditches	21
Section III (b) – Sites Draining to Lake Calumet, Calumet River or Indian Creek	22
Section IV – Roadway Design Guidelines	24
Section IV (a) – Public Roadway Design with Curb and Gutter	24
Section IV (b) – Typical Roadway Design without Sewers	25
Section V – Individual Property Design Guidelines	26
Section V (a) – Perimeter Yards	26
Section V (b) – Fences.....	29
Section V (c) – Driveways.....	29
Section V (d) – Parking Lots	31
Section V (e) – Screening of Off-Street Loading Facilities, Outdoor Storage and Trash Containers and Compactors	33
Section V (f) – Building Foundations.....	35
Section V (g) – Stormwater Systems/Best Management Practices.....	37
Section V (g)(1) – Vegetated Swales.....	37
Section V (g)(2) – Bioswales.....	39
Section V (g)(3) – Permeable Pavers.....	42
Section V (g)(4) – Bioretention	43
Section V (g)(5) – Stormwater Wetland	45
Section V (g)(6) – Vegetated Filter Strip.....	47
Section V (g)(7) – Level Spreader	48

Table of Contents, Continued

Section V – Individual Property Design Guidelines, Continued	Page
Section V (h) – Green Roof	50
Section V (i) – Lake and River Shorelines	52
Section V (j) – Transitional Landscapes	56
Section V (k) – All Other Non-Developed Areas	57
Section VI – Specifications	58
Section VI (a) – Trees and Shrubs	58
Section VI (b) – Groundcovers and Perennials.....	60
Section VI (c) – Native Prairie.....	61
Section VI (d) – Wetlands.....	64
Section VI (e) – Stormwater Wetlands	65
Section VI (f) – Woodlands	66
Section VI (g) – Soil Specifications.....	67
Section VII – Management And Maintenance	71
Section VII (a) – Trees and Shrubs.....	71
Section VII (b) – Low-Mow Turf	71
Section VII (c) – Natural Areas	73
Section VII (d) – Stormwater Best Management Practices	75
Section VIII – Resources	77
Section IX – Presentation Graphics	78
APPENDICES	
A. Recommended Plants by Community	A-1
Low-Profile Prairie	A-1
Mesic Prairie Mixes	A-1
Wet-Mesic Prairie Mixes	A-1
Wet Prairie Mixes	A-1
Woody Plant Lists.....	A-1
Woodland Mix	A-1
Low-Mow Turf	A-1
Perennials.....	A-1
B. General List of Acceptable Plants.....	B-1
General Plant List	B-1
Native Alternatives	B-1
C. Source List for Native Plant Materials.....	C-1
D. Sample List of Vendors	D-1
E. Overview of Best Management Practices	E-1
Table 1 – Infiltration Measures.....	E-1
Table 2 – Basins.....	E-1
Table 3 – Vegetated Practices.....	E-1
Table 4 – Small Areas.....	E-1
Table 5 – Water Inlets.....	E-1

PART I: DEVELOPMENT OPPORTUNITIES

Why Locate in the Calumet Industrial Corridor?

The Calumet Industrial Corridor on Chicago's southeast side is where manufacturers, developers and business owners find:

- Large tracts of land available for industrial development in Chicago.
- Competitive land prices.
- Excellent transportation by water, rail and road.
- Location in a large industrial region that extends from Chicago into northwest Indiana.
- Financial incentives for locating a business in the Calumet Area. State Enterprise and Tax Increment Financing (TIF) may be available.
- A qualified local labor force from the metropolitan area's large population, and convenient transportation for employees by bus, train, car or bike.
- The City of Chicago's strong commitment to preserve the Calumet Area for business and a model industrial corridor.

Large Tracts of Land in Chicago

Half the land available for industry in Chicago is found in the Calumet region. The Calumet Industrial Corridor is one of several of the City's 25 industrial corridors with lots 20 acres in size and larger.

It is the City's interest to establish the Calumet Area as a model industrial corridor that is environmentally sustainable over the long term.

Transportation

By Road:

Interstate 94, which runs from Montana to Detroit forms a western boundary to the Calumet Area. Interstate 90, which runs from Seattle to Boston, is on the east. Interstates 80, 55, 57, and 65 are all within 10 miles. Trucks coming from any market in the eastern and southern United States reach the Calumet Area before passing through downtown Chicago, saving on time and transportation costs.

A heavy truck route has been designated. Trucks in the Calumet Area can carry up to 143,000 pounds by acquiring a "no-fee" permit from the City. (Current Illinois law ordinarily allows only 80,000 pounds.) The long-term goal is to connect the Calumet Area to northwest Indiana, through Michigan and into Canada to create a regional uninterrupted heavy truck route. With more cargo carried, fewer trips are needed.

By Rail:

Chicago ships over 9 million intermodal containers per year, which is over twice that of any other metropolitan area in the United States. A significant amount of the intermodal traffic is centered in the Calumet Area, and has access to seven Class I regional major railroads.

By Water:

Transport by ships and barges is available. The Illinois International Port Authority's Port of Chicago at Lake Calumet Harbor and Iroquois Landing on Lake Michigan provide access to the Great Lakes, the St. Lawrence Seaway and Atlantic Ocean as well as to the Mississippi River and the Gulf of Mexico.

Financial Incentives**Tax-Increment Financing:**

The Lake Calumet TIF covers roughly 12,000 acres, and is the largest TIF district in Chicago. Created by the City of Chicago to finance redevelopment in areas where economic growth has lagged, developers can apply for funds to help leverage costs associated with land acquisition, job training, site preparation, infrastructure, environmental remediation, stormwater management, site and other pre-development costs in the Calumet Area.

Enterprise Zone Incentives:

Designated a State of Illinois Enterprise Zone #3, the Calumet Area provides a number of financial incentives for business. This list is a menu of possible incentives. Certain requirements must be met in order to qualify for the incentives. More detail is available in the Department of Planning and Development's (DPD) publication *Financial Assistance for Business*. (See "Resources" on back page.)

Sales Tax Exemption: Building materials purchased from Illinois retailers for renovation or construction are exempt from Chicago, Cook County, and Illinois sales tax..

Real Estate Transfer Tax Exemption: Property is ordinarily taxed \$7.50 per \$1,000 of acquisition price when it is sold. In the Calumet Area, property purchased for commercial or industrial purposes is **exempt from this tax**.

Investment Tax Credit: An Illinois Tax credit of 0.5 percent is available for investment in machinery, equipment or buildings in the Calumet Area.

Jobs Tax Credit: A one-time \$500 Illinois Income Tax credit is available for each job created by a business in the Calumet Area, provided the business hires at least five individuals certified by the State as dislocated or disadvantaged individuals.

Machinery and Equipment Sales Tax Exemption: Equipment purchases are provided a 6.25 percent sales tax exemption by the State of Illinois if they meet certain requirements.

Income Tax Deductions for Financial Institutions: Banks and other financial institutions are eligible for a special deduction from their Illinois corporate income tax returns for interest earned on loans given to properties in the Calumet Area.

Nature as Neighbor

In the Calumet Area, industry is intermingled with the open prairies and marshes that make up the Calumet Open Space Reserve. Four-thousand eight hundred seventy seven acres of the Calumet area are slated to become part of the Calumet Open Space Reserve, a matrix of open lands used for nature preservation and in many cases, recreation. Of these, 4,186 acres are in Chicago, and 691 are in the near south suburbs. These lands are rich with waterfowl and wildlife, and are being protected by a coalition of state and local agencies. Planned recreational activities include fishing, bird watching, hiking, cycling through a designated trail system.

Land Use Plan and Design Guidelines

The vision for the Calumet Area is to create a place where industry and nature coexist. Toward this end, the City of Chicago's Department of Planning and Development (DPD) have created a detailed land use plan that clearly defines which parcels are used for industrial redevelopment and what parcels are dedicated to nature preservation. (Copies of the *Calumet Area Land Use Plan* are available from DPD.)

In Part II of this document, DPD presents detailed design guidelines intended to help developers construct industrial landscapes compatible with the surrounding open space reserve system. The design guidelines favor the use of naturalistic plantings and landscape designs that complement the appearance and plant life of the Calumet Open Space Reserve. (*Calumet Area Design Guidelines* are available from DPD.) It is the City's vision that businesses choosing to invest in the Calumet Area be developed in ways that help improve the environment through thoughtful landscape management practices, stormwater management, and other means.

The enforcement of these guidelines will be through the City of Chicago's amended Zoning Code.

Public and Private Partners Working Together

The City of Chicago is committed to working with the private sector to attract new business and retain existing businesses. In the Calumet Area, the City will assist developers and business owners in consolidating land, receiving approvals for remediation of contaminated waters and soils, and designing a site that meets requirements of design guidelines.

PART II – DESIGN GUIDELINES

Introduction

This portion of the guidebook establishes and describes the City of Chicago's requirements for site design in the Calumet Area. It provides background information on soils, hydrology and ecology, and gives guidance as to how design guidelines are implemented on the ground. These standards for the Calumet Area supercede the traditional Chicago Landscape Ordinance and Guidelines that would ordinarily apply. The boundaries showing where the Calumet Area Design Guidelines apply can be seen on the Figure I-1.

This section of the document is important primarily for those charged with creating and implementing a site design either for a new enterprise or for the expansion of an existing business. The term "designer" that is used throughout applies to a team of professionals that includes building architects, landscape architects, soils scientists, site engineers and ecologists.

How to Get Started

Before drafting a site design, the most important thing to do first is contact the Department of Planning and Development (DPD). This should be done early in the process without waiting until there is a formal plan to show, because DPD staff has a great amount of information about types of soil on various sites, levels and locations of contamination and fill, locations of wetlands to be avoided in building, and other details. DPD can help save you time and money by providing this information up front.

In addition, DPD will give assistance in understanding how to use the practices for stormwater management that are prescribed by these guidelines, and it can offer advice about what permits are necessary and how to acquire them. Because industrial development in the Calumet Area is a high priority for the City of Chicago, DPD staff will expedite development plans and make the process as simple as possible.

How to Use the Design Guidelines

The tracts of available land in the Calumet Area differ from one another: sizes and soil types vary; topography changes from site to site; some locations have contamination problems while others do not. It is expected that some solutions suggested here will work for one site but not for another. Those who are expanding present facilities will have different challenges from those building on vacant land. The practices described are intended to serve as a menu of options for the developer.

For designers familiar with the Chicago Landscape Ordinance, special attention should be paid to planting specifications and other details that may be different for the Calumet Area. For example, the Ordinance specifies trees to be spaced uniformly along roadways. However, the Calumet Area Design Guidelines require trees to be clustered plant massings. These requirements are meant to enhance the naturalistic design scheme adopted for this industrial park.

The first two sections provide background on the hydrology, soils and ecology of the Calumet Area. Sections three through six present the City's guidelines for stormwater management, setbacks, plant selection and other factors.

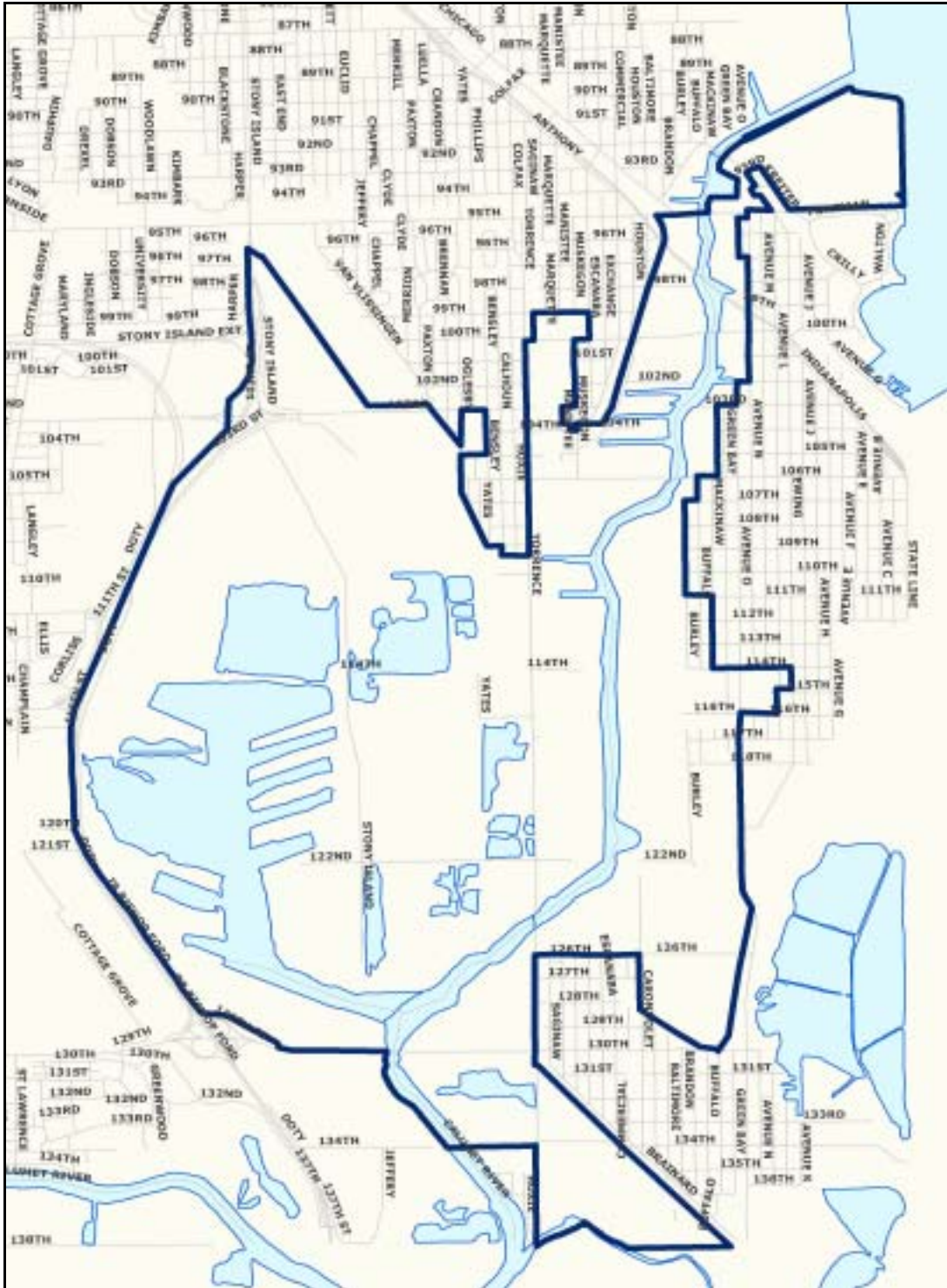

Figure I-1. Calumet Design Guidelines Boundary

Costs

The design scheme for the Calumet Area Industrial Corridor prescribed in the guidelines is natural in character. This was selected as a way to provide responsible, sustainable stormwater management; to provide a distinctive and unified character for the industrial corridor; and to make open spaces on industrial properties serve as good neighbors to the Calumet Open Space Reserve.

Designers will find that the installation costs for natural landscaping and best management practices for stormwater management will be the same or more than more conventional treatments. As one comparison, data show that conventional installation of sodded turf grasses may exceed \$12,000 per acre. Planting turf grass seeds may cost in the range of \$4,000 to \$8,000 per acre. Planting prairie grass and forb seeds is approximately \$2,000 to \$4,000 per acre; however, planting plugs costs considerably more. (*Natural Landscaping for Public Officials: A Source Book.*)

If there are substantial savings to be gained by the practices described in the design guidelines, they will come from maintenance. Because native perennial plants are well adapted to local soils, periods of drought, and conditions of the region, once they are established they require little or no watering, no fertilizer, herbicides, insecticides, or regular mowing; some natural landscapes may benefit from a periodic controlled burn. A healthy natural landscape can thrive on its own indefinitely, with little input or modification from humans.

Section I – Environmental Factors

Introduction

The Calumet Area was once a vast complex of marshes and grassland. Lower areas were open water, either lakes or rivers. Areas just a few feet higher in elevation were prairie or oak savanna. Most of the area was wet for some portion of the year.

Years of industrial activity have dramatically altered the region. Rivers have been channelized, landfills have created hills, and Lake Calumet has been dredged to be five times deeper than it was originally. Slag, a byproduct of steel making, has been deposited throughout the region and lies beneath much of the soil.

This section describes soil conditions and hydrology. The background provided here is intended to give designers an understanding of factors affecting site design.

Section I (a) – Soils

Historic Conditions and Types of Natural Soil

The soils within the Calumet Area have been significantly altered through many years of development and redevelopment, but underlying and intermingled with a variety of other materials are the following soil types. (These soil descriptions and interpretations are based on the *Geological Atlas of the U.S. Chicago Folio* by the U.S. Geological Survey (USGS) from 1902, and from information gathered from places nearby with similar conditions where soils have been mapped.)

Glacial Drift Lacustrine Soils – The soils that formed in the glacial drift, outwash and lacustrine materials tend to be deep, poorly drained to very poorly drained, with moderate to moderately slow permeability. These soils tend to have a seasonal high water table at or near the surface from November through June in undrained conditions. These soils have dark surface layers that are about 16 inches thick. This surface layer will have a slightly acid to slightly alkaline pH (6.1 – 7.8), and will have a loam or clay loam texture.

The middle layers of this soil will extend from 16 inches to about 45 inches. This layer will be gray in color due to its seasonal saturation. This layer will have a slightly acid to moderately alkaline pH. The texture ranges from clay loam or sandy loam, with an increase in sand in the deeper soils.

The lower layer of soil will have a marked increase in sand content and will show a continued stratification in soil textures. The color is typically gray to grayish brown. The pH ranges from neutral to moderately alkaline (6.6 – 8.4). The native plant community would have been wetlands dominated by marsh grasses, sedges, and reeds. Historically, these soils could be found west of the Bishop Ford Expressway and between 103rd Street to the north and the Little Calumet River to the south. If these soils are encountered intact, the development plan will require significant modifications for use.

Sandy Soils – The sandy soils in the Calumet region formed in the sandy beach deposits, which tend to be moderately well drained and have rapid permeability. The surface layer of these soils tends to be brown in color and about 10 inches thick. The soil texture is a very fine sand to a very fine loamy sand. The pH ranges from very strongly acidic to neutral (4.5 – 7.3).

The subsurface layers tend to become a yellowish-brown from the top of the soil down the profile. The pH ranges from strongly acid to neutral throughout. The texture ranges from fine sand to loamy sand. The sub-surface layers have blocky structure that gives way to single grain sand at the bottom of the profile. The predominant vegetation would have been sedges, marsh grasses, and cattails in the low areas, and oak savanna in the uplands.

One can expect to find these soils on the sand deposits that are now where Penn Central, C&W.I and N&W railroads and Torrence Avenue run east of Lake Calumet and land south of 130th Street between the Calumet River and the Bishop Ford Freeway. If these soils were encountered intact, the proposed development plan could use them, with modifications, for small building sites and road and parking lot fill. The landscaping potential is low due to poor water holding capacity.

Peat Muck Soils – The soils that formed in the peat muck areas tend to be very poorly drained with moderately rapid permeability. These soils consist of decomposed herbaceous organic materials five to six-feet thick over lacustrine or till deposits. These soils contain free carbonate minerals, so the pH was moderately alkaline (7.9 – 8.4). The layers are all black. The structure ranges from sub-angular blocky in the surface to massive at the bottom of the profile.

The native vegetation was marsh grasses, sedges, reeds and cattails. The historic area that this habitat encompassed was quite extensive on the north, eastern and southern shores of lake Calumet. This area today would be east of Lake Calumet to Torrence Avenue, east of Torrence Avenue to Wolf Lake, southeast of Lake Calumet to the confluence of the Calumet and Grand Calumet Rivers. The northern extent of these soils ran from the northwestern edge of Lake Calumet and east of Stoney Island.

These soils pose a large barrier for development. They are usually wet and are structurally unstable until the glacial or lake deposits, at their base, are reached. These soils are not suitable for construction projects. Landscaping that incorporates a wetland community is most appropriate for these soils.

Fill and Contamination of Soils

The dominant fills that were placed in the Calumet Area include:

1. Industrial waste
2. Municipal solid waste
3. Steel industry waste, primarily slag
4. Dredge spoils from the dredging of harbors and the channelization of the river
5. Biological sludge
6. Ashes and cinders from coking operations
7. Construction debris
8. Natural materials

The total volume of fill in the Calumet Area is staggering. There are very few parcels that have not been used as a depository for fill. Figure I-2 shows the extent of the fill. Depending on type and location, the presence of fill may or may not have an effect on how a site is designed.

The majority of fill material consists of waste from the steel industry, primarily slag. Slag is created when limestone is added to molten iron or steel to carry off impurities. It is poured while hot, cools like lava, and cements in place. Slag is alkaline and highly porous, with little water retention

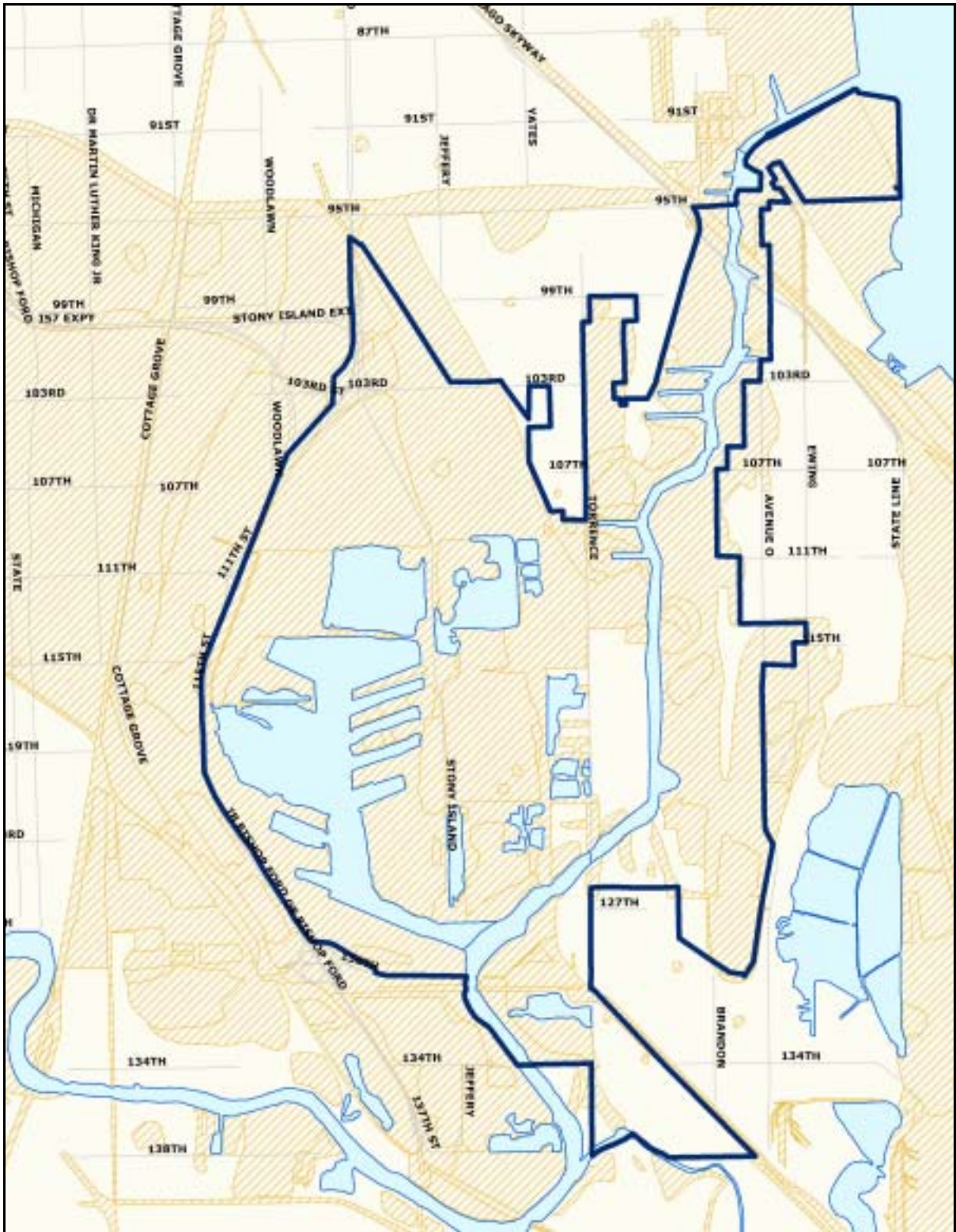

Figure I-2. Extent of fill material in the Calumet Area (Source: IL Geological Survey)

capability, which makes it poor material for landscaping. However, it is generally suitable for building, and has been used as landfill along the lakeshore to increase the amount of buildable land.

Another form of fill is dredge material consisting of sands and silts. It has been deposited mainly along the channels of ditches, streams and slips.

Industrial wastes are scattered throughout the region. The deposits along Lake Michigan are typically 20-60 feet, but can be as much as 80 feet of slag materials. In some cases, these materials are finer textured because they include ash and cinder deposits, both bottom and fly ash, that have a high percentage of 2-1 expandable minerals in them. These materials have a profound impact on the shrinking and swelling of soils at the surface, causing damage to roadways, sidewalks and other materials that are not anchored below these fills.

Many of the materials that were used as fill either included industrial waste with contaminants, such as oil and grease and heavy metals. In areas dominated by iron slag covered with ash and cinders, there are concentrations of silica, sulfate and trace metals. These affect the pH of groundwater, of near surface groundwater and surface waters in the area, raising the pH of ambient conditions of 7.3 up to 8.0 to a pH of 9.5-10.5. In most cases, the presence of contaminated materials in a specific area render it unsuitable for landscape plantings or natural area restorations.

How to Evaluate and Plan Remediation for Problems Associated with Fill

Though the presence of fill and contaminants can be serious problems, over the past two decades of dealing with the supervision of clean-up, government agencies have streamlined procedures and eliminated one-size-fits-all solutions. The Tiered Approach to Corrective Action Objectives (TACO) program developed by the Illinois EPA provides a mechanism for evaluating and creating an appropriate response to contaminants. TACO provides flexibility to site owners and operators in developing remediation objectives. Owners and designers can decide how best to manage their sites within TACO guidelines and determinations of remediation objectives are subject to review and approval of the Illinois EPA Bureau of Land.

Detailed information on the program is available on the Illinois EPA web site <http://www.epa.state.il.us/land/taco/index.html>

Section I (b) – Hydrology

Current Conditions

Though the landscape of the Calumet Area has changed dramatically, what has not changed is that the Calumet Area, at its fundamental core, remains a wetland. The water table lies only one foot underground in some places, and more typically, three to five feet.

For developers who build in the Calumet Area, water management is the key to success. That is why solutions contained in these design guidelines differ from typical industrial developments. The guidelines rely on the best management practices currently known for stormwater management. These practices slow the flow of stormwater and filter out pollutants with plant material and other means instead of relying solely on traditional sewers, culverts and retention basins.

Stormwater Infrastructure

The City of Chicago is unusual in that it is one of the few remaining areas within the state that is primarily served by combined sewers, carrying both stormwater runoff and sanitary flows. These combined sewers flow to the Metropolitan Water Reclamation District's (MWRD) facilities for treatment. During heavy rains, some of the combined sewer flows are diverted to the MWRD's Deep Tunnel system for temporary holding, prior to treatment. This system provides additional storage capacity during heavy rainfall events in order to minimize the potential for combined sewers to back up in commercial and residential structures. Figure I-3 shows the location of the TARP system through the Calumet region

Some of the Calumet Area's stormwater is now drained by roadside ditches that typically have steep side-slopes and are sparsely vegetated. Any new stormwater conveyance along roadways will be carried in pipes or a designer may choose instead to use vegetated swales which will reduce development costs and improve water quality.

There are locations in the Calumet Area that are not served by combined sewers. It is expected that development in these areas will need to be designed to incorporate a separate stormwater system that connects to a lake or river, or in some cases to a storm sewer or drainage swale.

Surface Water System

Lake Calumet drains into the Calumet River, which in turn drains north into Lake Michigan. Indian Creek connects Wolf Lake at the Indiana border to the Calumet River. The Thomas J. O'Brien Lock and Dam is south (or historically upstream) of the location where Lake Calumet joins the Calumet River. Water can flow in both directions at the lock and dam. A United States Geological Services (USGS) gage at the lock and dam measures flows leaving Lake Michigan and heading south to the Little Calumet River and ultimately the Calumet Sag Channel.

Most of the time the surface water elevation in the area is controlled by Lake Michigan. Although the elevation of Lake Michigan can vary, it is generally at about 579 feet above sea level. Lake Michigan's elevation is elevation 0 in Chicago City Datum (CCD), MSL 1929 Adj. (579.48 NGVD).

Groundwater

The water table in the area is often three to five feet below the ground surface at approximately 1 to 3 feet CCD (1929 Adj). However, groundwater elevations can vary from site to site and throughout the year at the same site. The relatively high water table provides challenges to the designer in preparing an effective stormwater system.

Floodplain

The flood elevation for the Lake Calumet area is approximately 5.5 ft CCD (MSL 1929 Adj). The lowest floor of any building (including basements) should be built one foot above that elevation. Commercial facilities must be flood proofed to that elevation

Water Quality

The designer will need to create a stormwater system that not only drains stormwater, but also mitigates water quality impacts from development activities. For example, driveways, parking lots and material handling areas can accumulate sediments, heavy metals, oils, greases, nutrients and other pollutants. Rainwater falling on these surfaces areas can wash pollutants into adjacent surface waters.

This manual includes a variety of best management practices that can be used to remove potential pollutants and improve water quality. Most of these practices include the use of native plant material to help absorb water and slow stormwater runoff. Examples of such methods are presented in Section V (g) of these guidelines. They have been developed as an integral part of the stormwater management of an individual lot, and also to build identity for the Calumet Area.

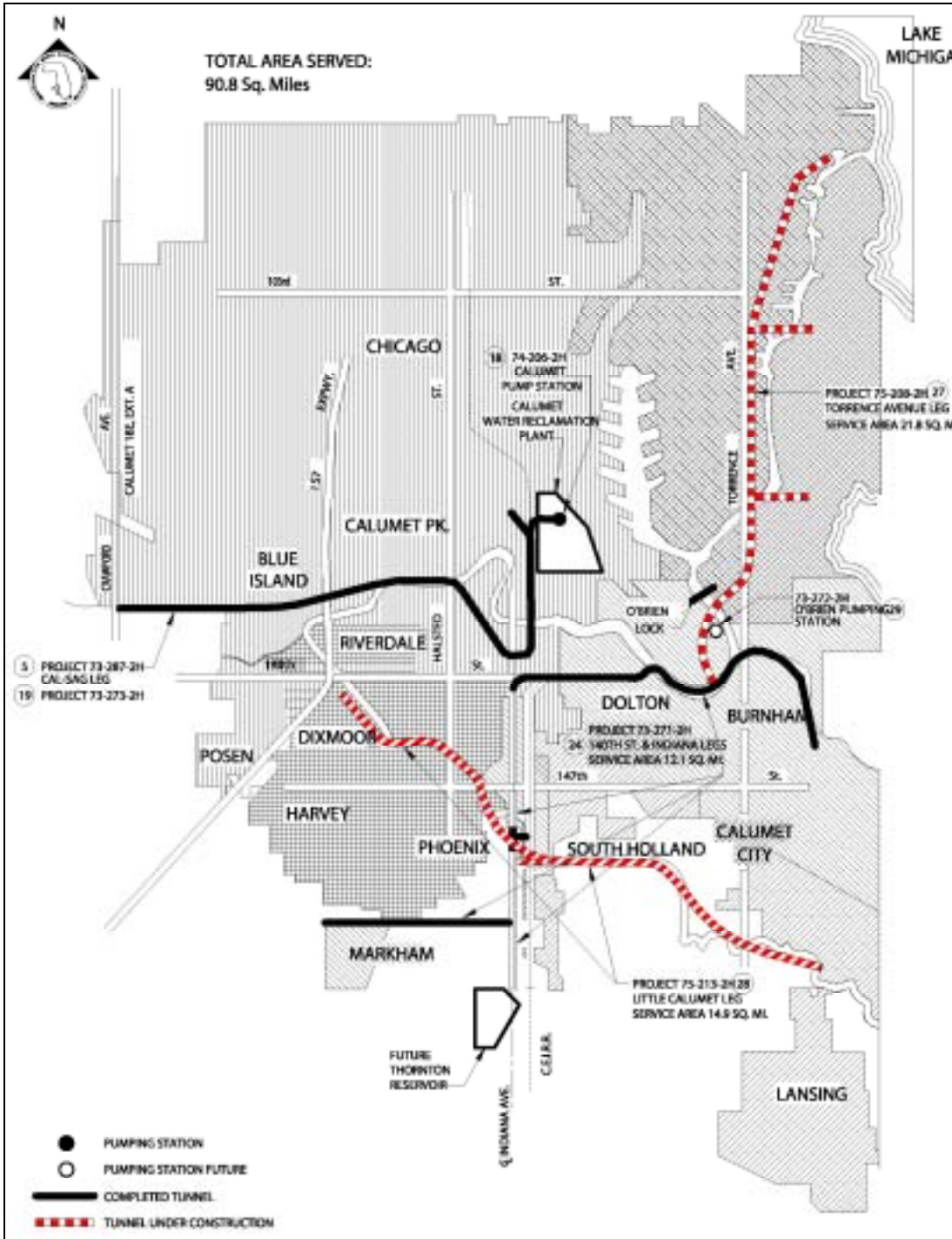

Figure I-3. Metropolitan Water Reclamation District TARP. (Source: MWRD)

Section I (c) – Natural Areas

Calumet Area Open Space Reserve:

The Calumet Area industrial park's main neighbor is the Calumet Area Open Space Reserve, a collection of wetlands, woods, prairies and vacant lands that provide important natural habitat. The highlight of the Open Space Reserve is the large numbers of water birds, such as herons, ducks and geese that nest in the wetlands or use them as a resting point during migration.

The surrounding natural areas are an asset for industry, as they provide an attractive location for business and they also prevent surrounding properties from being developed for residential or commercial uses that might not be compatible with industrial operations.

The Open Space Reserve is slated to contain 4,877 acres when completed. These are identified on the land use map in this document. Some of the land is already publicly owned, while other parcels remain in private hands. The 27 areas slated for preservation are described in detail in the *Calumet Area Open Space Reserve Plan*.

Natural Habitat Located On Industrial Sites:

With only a few exceptions, natural habitat in the Calumet Area appears on land already designated for preservation and is not present on industrial sites. However, in a few cases, land available for industrial development contains small wetlands, wetland buffers, land bordering creeks or rivers, grasslands, or other features that have value as natural habitat. DPD knows already where most of these sites are, and can advise designers early on. These small remnants of natural land can be useful as locations for stormwater retention, and may aid in developing overall stormwater management plans for the site. Site designs should avoid building on or harming such features. Small, isolated wetlands and other habitat sites are important, as they provide additional alternatives for shelter and food for wildlife.

Section I (d) – Permits

The permits discussed here apply to any region of the city, and are not specific to the Calumet Area. A typical Calumet Area site will need some but not all of these permits.

The owner of the property is ultimately responsible for acquiring all necessary permits before proceeding with development. As a first step, DPD can advise about which permits are necessary and which are unlikely to apply at a given site. DPD will guide owners to the right individuals to talk to in the various agencies, and can help expedite the permit process.

Soils:

Illinois Environmental Protection Agency (EPA) – Soil remediation efforts are regulated by the Illinois Environmental Protection Agency, Bureau of Land. Specifics of the Tiered Approach to Corrective Action Objectives (TACO) program as discussed before under Section 1(a). The designer is referred to the Illinois EPA for additional regulations regarding solid waste, hazardous waste and groundwater protection at <http://www.epa.state.il.us>.

Stormwater:

The release of stormwater from a site in the Calumet Area is governed by the ability of the downstream drainage system to receive that water. For example, a site draining directly to the river may have no release rate restrictions and thus the only stormwater facilities required are those needed to remove pollutants and improve water quality. (See the BMPs Section 3(h)). However, there are sites that have almost no downstream drainage capacity and must store all the rainwater received from a 5.8-inch, 24-hour duration rainfall event and have a zero release rate.

City of Chicago, Department of Water Management – One of the first steps for the designer must be a meeting with the City of Chicago Department of Water Management to determine the permissible release rate for the site. The allowable stormwater release rate is determined on a site-by-site basis. The City of Chicago Department of Water Management can be contacted at 312-747-8117. The website address is <http://www.ci.chi.il.us/Sewers/>.

City of Chicago, Department of Environment – DOE reviews projects located within floodplains within the City of Chicago. If the site is located in a floodplain, the City of Chicago Department of Environment will review planned development for compliance with the City's Floodplain Ordinance. In general, structures must be protected from flood damage to one foot above the base flood elevation. *Chapter 16-6 Flood Control Ordinance* can be found at www.municode.com. The Department of Environment can be reached at 312-744-7606. The website address is <http://www.ci.chi.il.us/Environment/index.html/>.

Illinois Department of Natural Resources-Office of Water Resources – The Illinois Department of Natural Resources-Office of Water Resources (IDNR-OWR) regulates work in public waters and floodways. In the Calumet Area, this means that a developer must submit a permit for construction within or along the water bodies in the area, which include Lake Calumet, Calumet River and Indian Creek. In general, the IDNR-OWR is concerned about impediments to flood flows, loss of flood storage and obstructions to navigation.

The Department's Chicago area regulatory office can be contacted at 847-608-3100. The website address is: http://dnr.state.il.us/owr/content/OWR_index.htm.

United States Army Corps of Engineers – The U.S. Army Corps of Engineers (Corps) regulates the deposition of fill or dredged materials into waters, including wetlands, as dictated by the Clean Water Act. The Corps also regulates any filling of navigable waters as part of the Rivers and Harbors Act. If a site is adjacent to or contains a water body, a Corps permit likely will be required for all work below the designated ordinary high water line. If it is a navigable waterway, a permit likely will be required for all work within the navigation channel. If the site contains a jurisdictional wetland, a Corps permit also will be required for any discharge of dredge or fill material into that wetland.

In general, the Corps' goal is to ensure that there are no obstructions to navigation and that the discharges of fill into the nation's waters are avoided unless there are no practicable alternatives. A stormwater plan showing best management practices used to treat runoff before it reaches the water body or wetland will be useful in obtaining Corps permits or authorizations.

The Corps has a Chicago office. The Regulatory Functions group that handles permitting in that office can be contacted at 312-353-6400. The website address is <http://www.usace.army.mil/ncc/>.

Natural and Historic Resources Agencies:

Only a few sites will need a sign-off from the U.S. Fish & Wildlife Service, Illinois Department of Natural Resources or the Illinois Historic Preservation Agency. If the designer contacts DPD, its staff

will know if there are natural or historic resources present that require special attention on a given site. Most wetlands and natural areas are located on the Calumet Open Space Reserve, and not on lands designated for industrial use. There are a few historic bridges and other structures of historical note on industrial parcels; these are known and documented by DPD.

Section II – Soil Design Considerations

Section II (a) – Modification of Soils

The most economic way to improve existing soil materials is by adding organic amendments available locally. The specialized and in some cases contaminated landscape conditions in the Calumet Area warrant the use of specialty soil mixes. Table II-1 provides a Landscape Soil Matrix for the Lake Calumet Planning District. Table II-2 through Table II-6 present details of soil properties for the specialty soil mixes. This includes lightweight soils, deicing salt friendly soils, beach soils and other specialty soils for the redevelopment of brownfields. These soils are consistent with soil materials used throughout the City of Chicago but have been tailored to accommodate the unique conditions in the Calumet Region.

**Table II-1
Landscape Soil Matrix, Calumet Area**

Soil Type	Use	Attribute													
		Foot Traffic	Light Vehicle Traffic	Soil Density (dry) (Max PCF)	Restricted Rooting Space	Irrigation	Surface Drainage (Min)	Subsurface Drainage	Salinity (SAR)	Max Slope	Lightweight Application	Min. Depth (In.)	Max. Depth (In.)	Created Mix Allowed	Amended Natural Soil Allowed
General Landscape	GL, SWR, WT	L	N	90	N	-	2%	S	≤ 8	2:1	N	12	36	N	Y
General Planter	GP	N	N	85	Y	S	2%	R	≤ 8	2:1	Y	18	42	Y	Y
Median Planter	MP	N	N	90	Y	R	1%	R	≤ 5	3:1	N	24	42	Y	S
Mixed-Use Landscape	GL, SWR, WT, TR	L	N	100	N	-	2%	S	≤ 8	2:1	N	18	42	N	Y
Tree & Shrub Bed	TS, GP	N	N	100	N	S	1%	R	≤ 5	2.5:1	N	24	42	Y	Y
High Traffic Turf	TR	H	O	105	N	R	1%	R	≤ 8	4:1	N	9	18	R	N
Low Traffic Turf	TR	L	O	105	N	R	1%	R	≤ 8	3:1	N	9	18	Y	S
Retention -- Stormwater	SWR, WT	N	N	105	Y	N	0.25%	N	≤ 13	N/A	N	9	18	Y	Y
Infiltration -- Stormwater	SWI, GL	L	N	105	N	N	0.50%	R	≤ 8	N/A	N	12	18	S	Y
Amended Slag-Non Expansive	GL, SW	L	L	105	Y	N	1%	S	≤ 8	3:1	N	6	12	R	R
Amended Slag-Expansive	SWR, WT	N	N	105	Y	N	2%	R	≤ 8	4:1	N	6	12	R	R

<p>Y = Yes N = No N/A = Not Applicable</p>	<p>L = Light H = Heavy O = Occasional R = Required S = Recommended</p>	<p>GL = General Landscape GP = General Planter MP = Median Planter SWI = Stormwater – Infiltration SWR = Stormwater – Retention TR = Turf WT = Wetland</p>
---	---	---

General Landscape Soil:

General landscape soil is for all landscape uses including planting beds, non-trafficked turf, tree and shrub planting and parkway backfill.

**Table II-2
General Landscape Soil**

Property	Size	Unit of Measure	Range/Limit
Texture			
Gravel	> 4.76 mm	%	≤ 2
Gravel	> 2.00 mm	%	≤ 7
Sand	> 0.50 mm	%	10 – 30
Sand	> 0.053 mm	% of total sand	Not to exceed 20
Silt	0.053 - 0.002 mm	%	Not to exceed 70
Clay	≥ 0.002 mm	%	Not to exceed 27
Si + Cl		%	Not to exceed 90
Organic Matter		% dw	3.0 – 12.0
pH			5.5 – 7.4
Soil Density		pcf	Not to exceed 90

Mixed Use Soil:

Mixed use soil for all landscape uses including general planting, tree and shrub planting, brownfield restoration, and vegetation of disturbed areas. This soil has less restrictive requirements and is most appropriate for lower quality landscape areas including side lots, partially vegetated storage areas and temporary fills.

**Table II-3
Mixed Use Soil for Landscape Uses**

Property	Size	Unit of Measure	Range/Limit
Texture			
Gravel	> 4.76 mm	%	≤ 3
Gravel	> 2.00 mm	%	≤ 7
Sand	> 0.50 mm	%	5 – 30
Sand	> 0.053 mm	% of total sand	Not to exceed 20
Silt	0.053 – 0.002 mm	%	Not to exceed 70
Clay	< 0.002 mm	%	Not to exceed 27
Si + Cl		%	Not to exceed 90
Organic Matter		% dw	3.0 – 10.0
pH			5.5 – 7.5
Soil Density		pcf	Not to exceed 110

General Planter Mix:

General planter soil is for use in at-grade and small above grade planters where large quantities of deicing salts will not be introduced into the soil. Planter mixes should be used in confined spaces only as they generally do not have sufficient strength to support large plant materials without subsidence.

**Table II-4
General Planter Mix**

Property	Size	Unit of Measure	Range/Limit
Texture			
Gravel	> 4.76 mm	%	≤ 1
Gravel	> 2.00 mm	%	≤ 5
Sand	> 0.50 mm	%	30 – 70
Sand	> 0.053 mm	% of total sand	Not to exceed 15 of the sand fraction.
Silt	0.053 – 0.002 mm	%	Not to exceed 45
Clay	< 0.002 mm	%	Not to exceed 20
Si + Cl		%	Not to exceed 40
Organic Matter		% dw	3.0 – 12.0
pH			5.5 – 7.0
Soil Density		pcf	Not to exceed 85

Median Planter Mix:

Median planter soil is for use in at-grade and above grade planters where large quantities of deicing salts are likely to be introduced into the soil. Planter mixes should be used in confined spaces only as they generally do not have sufficient strength to support large plant materials without subsidence. This mix is prepared using 2 parts topsoil and 1 part FA2 sand.

**Table II-5
Median Planter Mix**

Property	Size	Unit of Measure	Range/Limit
Texture			
Gravel	> 4.76 mm	%	≤ 2
Gravel	> 2.00 mm	%	≤ 5
Sand	> 0.50 mm	%	25 – 33
Sand	> 0.053 mm	% of total sand	Not to exceed 20 of sand fraction
Silt	0.053 – 0.002 mm	%	45 – 70
Clay	≤ 0.002 mm	%	0 – 25
Si + Cl		%	
Organic Matter		% dw	3.0 – 8.0
pH			6.5 – 7.0
Soil Density		pcf	Not to exceed 110

Tree and Shrub Bed Mix:

Tree and shrub bed soils are designed for the development of optimum rooting conditions for trees, shrubs, and groundcovers. This soil should not receive foot or vehicle traffic.

**Table II-6
Tree and Shrub Bed**

Property	Size	Unit of Measure	Range/Limit
Texture			
Gravel	> 4.76 mm	%	0
Gravel	> 2.00 mm	%	≤ 1
Sand	> 0.50 mm	%	35 – 80
Sand	> 0.053 mm	% of total sand	Not to exceed 10
Silt	0.053 – 0.002 mm	%	Not to exceed 35
Clay	< 0.002 mm	%	Not to exceed 15
Si + Cl		%	Not to exceed 35
Organic Matter		% dw	3.0 – 12.0
PH			5.0 – 6.8
Soil Density		pcf	Not to exceed 100

Section III – Stormwater Management Guidelines

Effective management of water is critical to successful building in the former wetlands of the Calumet Area. To handle the substantial amounts of water present in the Calumet Area and that flow through it during storms, *every square foot of open space needs to be considered for how it can be used to help manage water.*

Buildings must be surrounded by plants that can help absorb water and dilute pollutants. Even hard surfaces such as parking lots, lawns, and rooftops can be designed to help absorb rainwater and slow its flow toward waterways.

In Calumet, landscape designs must perform their primary functions: a parking lot has to support cars, a loading zone must be located in a place and built in such a way to support heavy trucks. But each component of the design must also be thought through in such a way that it can contribute to improving stormwater management, or at the very least, that it doesn't increase problems. Even sites that have access to sewers are expected to include some form of on-site stormwater management through the use of best management practices.

Section III (a) – Sites Draining to Combined Sewers, Storm Sewers or Existing Ditches

This section provides guidelines for those sites where water drains to the MWRD's deep tunnel system, combined sewers, storm sewers, existing ditches, or stormwater facilities on an adjacent lot that have been designed to accommodate stormwater from neighboring sites. Figure III-1 shows the location of sewers in the Calumet Area.

Design Objectives:

- Route all surface water runoff through a stormwater management system incorporating best management practices (BMPs) for improving water quality before the water leaves the site.
- Reduce site runoff through infiltration techniques and on-site stormwater storage options.
- Integrate stormwater features into the landscape plan prepared for the development.

Considerations:

- Much of the area has a high groundwater table as described in Section 1(b)--Hydrology.
- The allowable release rate from the site will be based on the capacity of the receiving system.

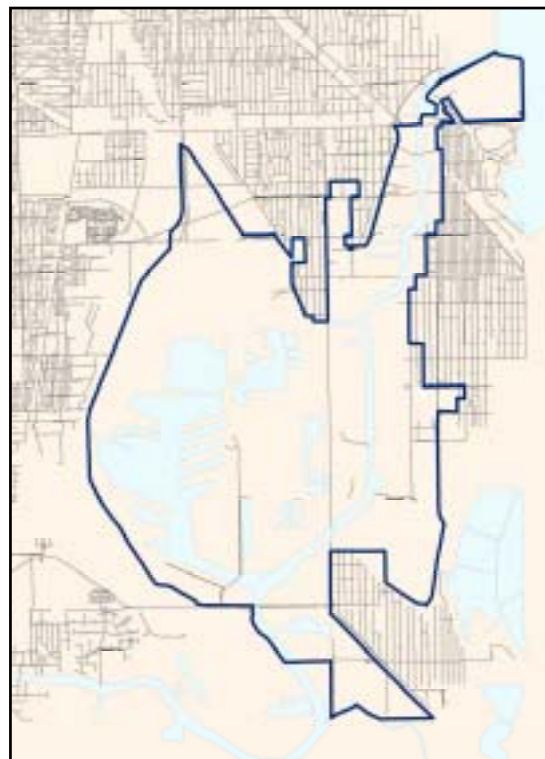

Figure III-1. Calumet sewer map.

- Previously deposited waste materials that may exist on a developable property may limit stormwater infiltration options. Soil borings must be obtained to determine the nature of subsurface material.
- Most areas drain into a combined sewer system, but some areas do not have access to an existing combined sewer.
- The lack of available sewers may require that 100 percent of the City of Chicago's 5.8 inch, 100-year, 24-hour rainfall runoff volume be retained on site.
- Working with adjacent property owners to construct joint stormwater features for planning, construction, and maintenance can provide cost savings and efficiency.
- Locating stormwater management facilities next to natural areas, Calumet Open Space Reserve properties, or established stormwater systems on adjacent properties will enhance efficiency and wildlife habitat.

Design Standards:

- Contact the City's Department of Water Management to obtain the allowable stormwater release rate for the development parcel. Each site will be evaluated separately based on the capacity of the receiving sewer or ditch.
- Refer to the Department of Water Management current edition of the "Permit Requirements and Fees" booklet for design criteria to be met.
- Work with the City of Chicago Department of Environment and Department of Water Management to determine whether the percolation rate can be considered to lower the required storage volume, and if treatment of the runoff is required.
- Where there is no outlet for infiltration basins, provide 0.48 acre-feet of stormwater storage per acre developed to retain the 5.8-inch, 100-year, 24-hour duration rainfall.
- Locate stormwater management facilities or BMPs next to existing open space or natural areas (e.g., the Reserve, wetlands, remnant prairie, etc.) or stormwater facilities on adjacent lots.
- Refer to Section V (g) for design specifics related to BMPs.
- Consult Section II for design specifics regarding soil types and concerns related to stormwater management.

Section III (b) – Sites Draining to Lake Calumet, Calumet River or Indian Creek

This section provides guidelines for sites where stormwater discharges directly into a lake, river, stream or channel. Stormwater management in these cases focuses primarily on improving water quality prior to discharge.

Design Objectives:

- Route all surface run-off through a stormwater management system incorporating best management practices for improving water quality before it is conveyed from the site.
- Reduce site runoff through infiltration techniques and on-site stormwater storage options, where possible.
- Use "green" infrastructure in lieu of structures (i.e., storm sewer systems) to convey stormwater.
- Integrate stormwater features into the landscape plan prepared for the site.

Considerations:

- Much of the area has a high groundwater table.
- Previously deposited waste materials that may exist on a developable property may limit stormwater infiltration options. Soil borings must be obtained to determine the nature of subsurface material.
- In general, sites with direct access to an adjacent water body will be required to utilize the water body as an outlet with restricted release requirements to improve the water quality of the discharge.
- Any outfalls that are constructed must be designed to prevent erosion of the shoreline.
- Working with adjacent property owners to construct joint stormwater features for planning, construction, and maintenance can provide cost savings and efficiency.
- Permits from the U.S. Army Corps of Engineers, Illinois Department of Natural Resources Office of Water Resources, and the Illinois Environmental Protection Agency will often be required.

Design Standards:

- Contact the City of Chicago Department of Water Management to determine stormwater detention requirements for the developable parcel.
- Stormwater must be treated via a wet basin or wetland prior to discharging to the water body. The required volume of detention shall be based on a 2-year, 24-hour storm event with a maximum allowable discharge rate of 0.04 cfs/acre. (Figure for minimum storage requirements).
- All wet basins and wetland basins must have means to safely accommodate overflows in excess of the 2-year storm event up to and including the 100-year storm event.
- Refer to the Department of Water Management current edition of the "Permit Requirements and Fees" booklet for design criteria to be met.
- Refer to Section V(g) for design specifics related to BMPs.
- Consult Section II for design specifics regarding soil types and concerns related to stormwater management.

SECTION IV – ROADWAY DESIGN GUIDELINES

Where served by combined sewers, roadways can be developed with curb and gutter. Other non-sewer areas need to accommodate open drainage systems. This section provides direction in designing the landscape for both these conditions. The design objectives for each have been developed to support an integrated stormwater management system, while at the same time sustaining the naturalized design theme established for the Calumet Area.

Section IV (a) – Public Roadway Design with Curb and Gutter

This cross-section applies to public rights-of-way and private drives where combined sewers are available and a closed system is used to drain roadways. It will be used along existing public streets that form the boundary of the Calumet Area, and in those areas where curb and gutter exists along established public and private roadways.

Design Objectives:

- Provide an aesthetically appealing roadside that supports the natural character of the design scheme for the Calumet Area, while remaining compatible with the existing, established urban streetscape.
- Have trees grouped or massed rather than lined up at symmetrical intervals.
- Create design consistency among linear rights-of-way throughout the Calumet Area industrial district.
- Provide opportunities for adding landscaping to soften fences located next to the street.

Considerations:

- Conventional lawns will be used in the parkways to promote design compatibility between the new and established parkways.

Design Standards:

- Trees should be clustered, rather than spaced evenly in the parkway, to support the natural design scheme of the area.
- The number of trees required is based on the lineal frontage of the property, including all driveway openings.

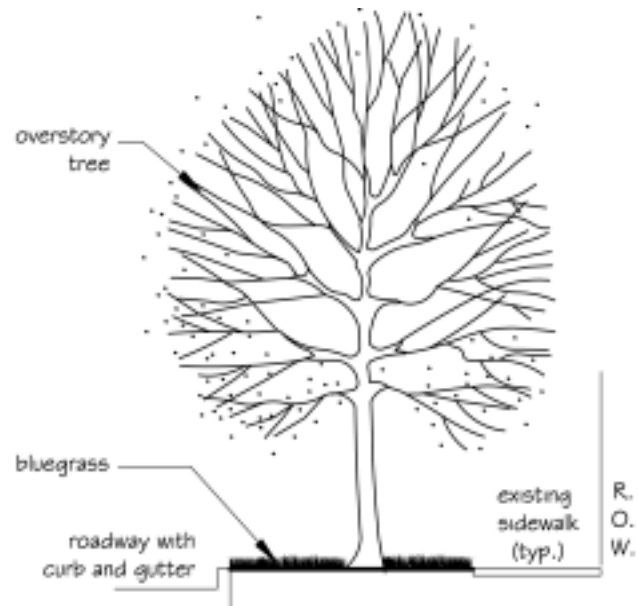

Figure IV-1: Roadway Design with Curb and Gutter

Recommended Plantings:

Components	Plant Community	Specifications
Parkway	Bluegrass Overstory Trees, Woody Plant List #2	Seed or sod 3” caliper, minimum 1 tree/40 linear feet of frontage 6’ branch height, minimum

Section IV (b) – Typical Roadway Design without Sewers

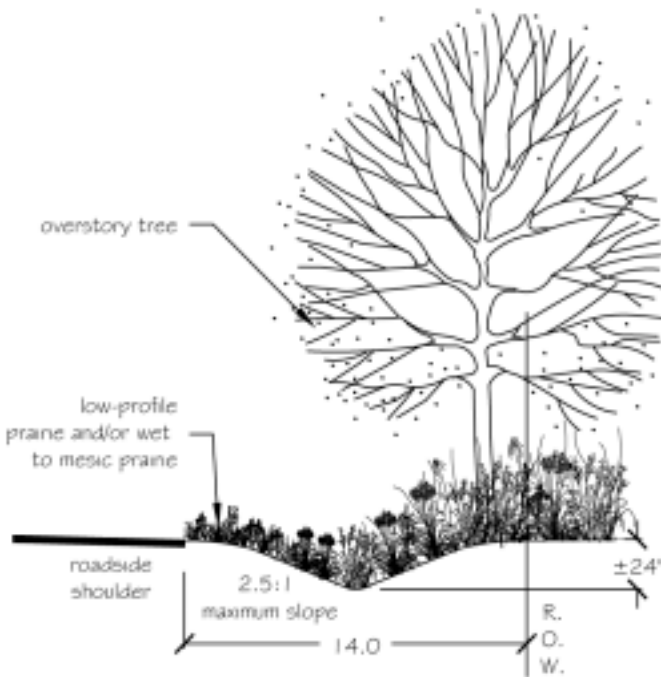

Figure IV-2: Typical Section Where Water is Not Retained

Public sewers are not present or available in many areas of the Calumet Industrial Corridor. This cross-section applies to public rights-of-way where storm sewers are not available and where roadways and adjacent properties are drained into open channels that parallel the road. The standards applied here may be used along public streets within and along the boundary of the Calumet Area.

Design Objectives:

- Provide a natural and aesthetically appealing roadside by grouping and massing trees.
- Create design consistency among linear rights-of-way.
- Encourage infiltration and filter out pollutants from lateral surface flow from roadways and adjacent properties.

- Regrade and stabilize the roadside ditches with native plantings, turning the steep, unmaintained ditches into vegetated swales.
- Minimize maintenance for public agencies and private property owners.
- Final design specifications to be determined by the Department of Water Management.

Considerations:

- Sidewalks are not proposed or required in the Calumet Industrial Area. This allows the area associated with the roadside swale to be maximized for stormwater retention using vegetation to slow runoff and to enhance water quality.
- The swale that is associated with this design should be constructed or regraded within the existing right-of-way, next to the established shoulder. Where possible, a slope of 3H:1V or less should be created to maximize landscaping and minimize erosion. (See Figure IV-2.)

- In those areas where the roadside swale has been or will be constructed to retain water, slopes should not exceed 2H:1V. This is essential to avoid clogging that can otherwise occur from erosion. A 2H:1V slope can be stabilized with the type and quantity of vegetation that is proposed, provided appropriate erosion control methods are implemented. (See Design Standards, below, Figure IV-7 and Section VII, Specifications and Details).

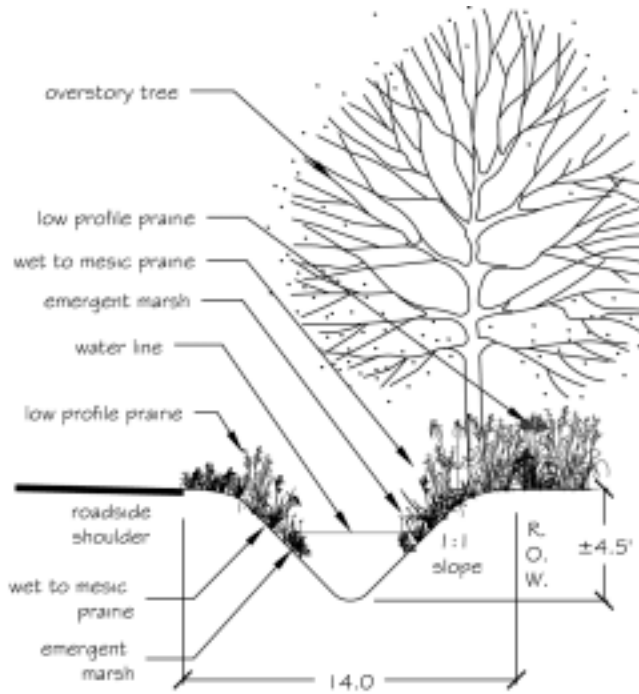

Figure IV-3: Typical Section Where Water is Retained

Design Standards:

- Follow the guidelines found in Section VI for eradicating existing, invasive vegetation and for soil preparation
- Design roadside swales with plants that tolerate salts and pollutants:
 - Where the water table is greater than 6” below the surface (see Figure IV-3), use the Low-Profile Prairie Mix #1.
 - Where the water table is within 6” of surface (see Figure IV-7), use the Wet-Mesic Prairie Mix #1.
- Use P300 synthetic TRM blanket by North American Green (or approved equal on slopes) to ensure slope stabilization.

- Remove debris on regular basis to avoid clogging, and to maximize the conveyance of stormwater in the roadside swale.
- Final design specifications to be determined by the Department of Water Management.

Recommended Plantings:

Components	Plant Community	Specifications
Top of Slope to 6” above NWL	Low-Profile Prairie, Mix #1	Seed: 96.5 lbs. per acre
NWL to 6” above NWL	Wet-Mesic Prairie, Mix #1	Seed: 77.2 lbs. per acre
NWL to 12” below NWL	Emergent Marsh, Mix #1	Plugs: 4000 per acre, 18” o.c. (avg.)
Interior Edge of Parkway	Overstory Trees, Woody Plant List #3	3 “ caliper, 1 tree/40 lineal feet OR 1½” caliper, 2 trees/50 lineal feet

Section V – Individual Property Design Guidelines

Sites and the requirements of site occupants vary widely, but the design guidelines cover most situations typical for the Calumet Area. The setbacks from waterways that are required in the Calumet Area are consistent with the standards developed by the City for the Chicago River.

Section V (a) – Perimeter Yards

Perimeter yards are the open spaces along property lines. No pavement or other hardscape features will be allowed in perimeter yards, with the exception of access drives. These open spaces offer the opportunity to create continuity between developments, and in some cases, will be useful in tying together drainage systems and green corridors. They are also logical locations for landscape features such as vegetated swales that facilitate stormwater management.

Design Objectives:

- Create an identifiable landscape theme that is interwoven among and between industrial properties.
- Responsive to site specific constraints.
- Establish a low-maintenance plant community punctuated with massings of native canopy, understory trees and shrubs to create woodland areas and to visually define and separate individual properties.
- Create continuity of landscapes within perimeter yards.
- Allow the installation of BMPs in perimeter yards visible from a public street, provided they are designed to be compatible with the landscape design theme developed for the Calumet Area.

Considerations:

- Maintenance of native prairie planted in perimeter yards will require periodic burning. Plant trees and shrubs in clusters to facilitate the establishment of mowed firebreaks and buffers before burning.
- Flexibility in setbacks are only for preservation of existing natural features, BMP design, and environmental constraints.
- Effective erosion and sediment controls will be important to establish and maintain front, rear and side yard landscaping to prevent the discharge of sediments into adjoining properties or waterways.
- Stormwater management facilities using best management practices can be constructed in perimeter yards.

Design Standards:

Front and Corner Side Yards: 30-foot setback from all property lines facing streets

- Least flexibility in adjusting setback.
- Install low-profile prairie in this setback where parking or a vehicular use area is located along a public street.
- Require overstory and intermediary trees in the front yard (1 overstory tree per 40 lineal feet).
- Group, mass or cluster overstory and intermediary trees with prairie.

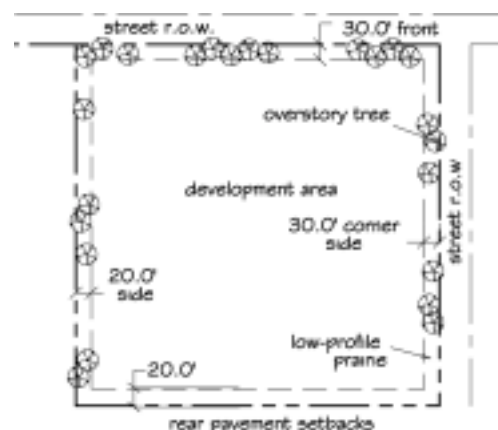

Figure V-1: Minimum 20-foot required front, corner side, interior side and rear yards on a typical lot

Interior Side and Rear Yards: 20-foot setback from side property lines

- Install low-profile prairie in this setback (see Figure V-1).
- Plant overstory trees at an overall density of 1 tree per 65 lineal feet. Group, mass or cluster overstory and intermediary trees to avoid shading low-profile prairie.

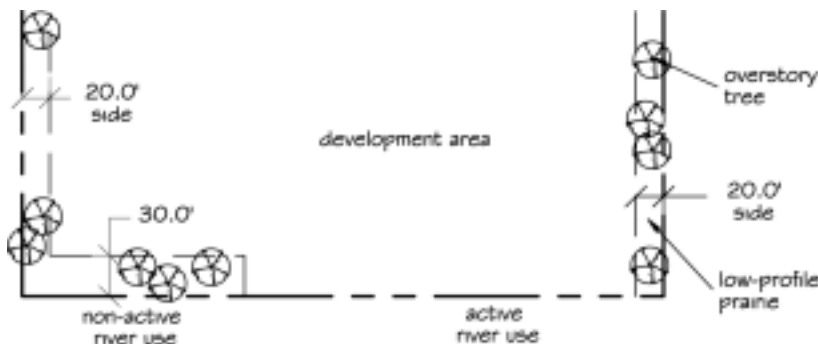

Figure V-2:

Required rear or interior side yards next to Lake Calumet or the Calumet River:

- 30 feet from top of bank, where use is not river dependent; and
- 0 feet, where use is river dependent

River Dependent Rear or Interior Side Yards Next to Lake Calumet or the Calumet River: Zero setback

- No setback is required for uses dependent on the waterway. River-dependent activities are defined as those that can be carried out only on, in, or adjacent to a waterway. A typical use in the Calumet Area would be an area where materials are loaded and unloaded from boats and barges. (See Figure V-2).
- Design the interface between the river and land to:
 - Stabilize the shoreline.
 - Route all stormwater runoff from surfaces next to the river or lake through a landscaped stormwater BMP before discharging stormwater water into the adjacent waterway.
 - Refer to Section V(h) for design guidelines required at the water's edge.

Non-Dependent River Use Rear or Interior Side Yards Next to Lake Calumet or the Calumet River: 30-foot setback.

- Maintain a minimum 30-foot setback from top of bank, where the use of a lot does not require direct access to the water (see Figure V-2).
- Measure the minimum setback from the top of bank.
- Plant these yards in accordance with Section V (h) of these guidelines.

Recommended Plantings for Perimeter Yards:

Components	Plant Community	Design Standards
Groundcover	Low-Profile Prairie Mix #4	Seed: 47.7 lbs. per acre Plugs: 50 per acre in 2.5" containers @ 24" o.c. (avg.)
Overstory Trees	Woody Plant List #2 or #4	3' caliper, 1 per 40 linear feet OR 1 per 65 linear feet, as applicable
Intermediary Trees	Woody Plant List #2 or #4	6' tall ball & burlap; 25 trees per 1,000 sq ft
Deciduous Shrubs	Woody Plant List #2 or #4	30" height; 7 per 1,000 sq ft

See Section V (h) for landscape requirements within non-active rear or interior side yards next to Lake Calumet or the Calumet River

Section V (b) Fences

Fences:

In the Calumet Area, fencing is optional and is not recommended along public streets or private drives.

If fencing is desired by the user, ornamental fencing consistent with Figure V-3 is required.

Ornamental fencing may be four feet tall, if provided around an area that does not need to be secured, or up to eight feet tall, if security is required. Fences above eight feet will require an exception from the Zoning Administrator. Security tops are optional, depending on the needs of the user.

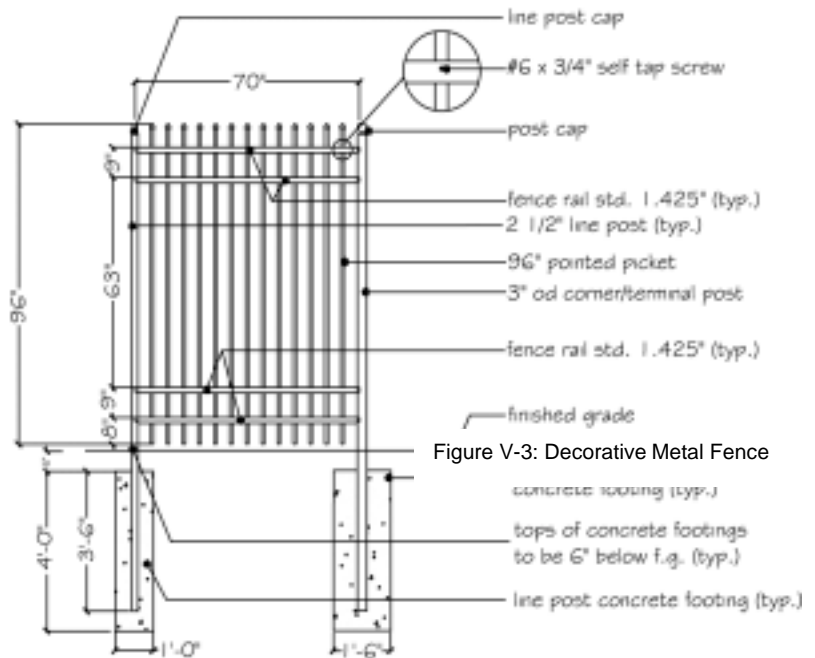

Figure V-3: Decorative Metal Fence

Section V (c) – Driveways

This section addresses landscape guidelines for all private access drives that connect property entrances with internal facilities such as parking lots, loading areas and building entrances. Paved surfaces serving only as short connections between public streets and vehicular facilities need not conform to these guidelines, provided such drives do not extend more than 35 feet into the lot.

Design Objectives:

- Create a consistent and identifiable landscape along all driveways in the Calumet Area.
- Provide an aesthetic and functional landscape transition between paved internal roadway surfaces and adjoining vegetated areas.

- Establish a narrow, drivable shoulder at the outer edge of the road to prevent ruts at the edge of the roadside that might otherwise be created from vehicles whose tires leave the paved drive.
- Develop a low-profile, salt tolerant vegetated strip next to the shoulder.
- Create a common wet/mesic prairie design element for interconnected vegetated swales.
- Offer a low-profile vegetated transition between the edge of a driveway and adjoining upland areas.

Considerations:

- The use of permeable pavers is encouraged to provide infiltration of stormwater, where possible, and to enhance water quality by filtering out pollutants (see Section V (g) 3, Permeable Pavements, below).
- If permeable pavers are used for drive lanes and shoulders and/or parking spaces, then differentiate these areas by either painting stripes or using pavers that are a different color.

Design Standards:

- Provide four-foot wide, minimum shoulders at the edge of all drives (see Figure V-4).
- Construct shoulders with a permeable material such as stone or other aggregate that exhibits infiltration characteristics and provides support for vehicles.

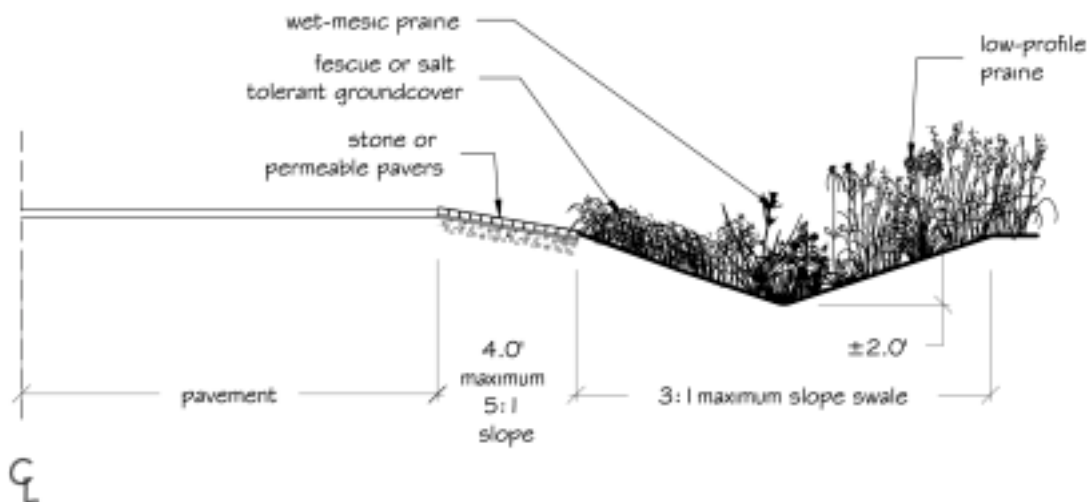

Figure V-4: Typical cross-section for interior driveways without curb and gutter

- Develop shoulders with flat surfaces, ensuring that slopes do not exceed 5:1.
- Maintain side slopes that are 3:1 or flatter where swales are required next to driveways.
- Plant fescue or salt-tolerant groundcover on the upper edge of the swale, between the shoulder and the centerline of the swale.

- Install wet mesic prairie in the swale at and below the line where soils are typically saturated for periods greater than 24 hours.
- Plant low-profile prairie on the upper/outside edge of the swale, above the zone of saturation

Planting Recommendations:

Components	Plant Community	Design Standards
Roadside	N/A	Compacted stone or permeable pavers
Upper/inside edge of Swale	Low-mow turf <i>OR</i> Low-profile prairie Mix #1	Seed: 5 lbs. per 1000 s.f. Seed: 96.5 lbs. per acre
Saturated Zone of Swale	Wet-mesic Prairie Mix #1	Seed: 77.2 lbs. per acre
Upper/outer edge of Swale	Low-profile Prairie Mix #4	Seed: 47.7 lbs. per acre Plugs: 50 per acre in 2.5 containers @ 18" o.c. (avg.)

Section V (d) – Parking Lots

Guidelines for parking areas apply to all outdoor parking facilities used by employees, visitors and vendors. These typically consist of large paved areas with defined drive isles separated by landscaped islands and medians that support BMPs for stormwater.

Pollutants from the runoff from parking lots can contaminate the groundwater. The constraints of the Calumet Area's high water table, flat topography, and lack of sewers makes surface runoff from parking lots in this region of particular concern. That is why parking lots are expected to utilize practices from the menu of options of BMPs suggested in this document.

Parking lot screening will be provided by landscaping within the minimum 20-foot setback requirement (see Section V (a), which will include low-profile prairie and scattered trees.

Design Objectives:

- Improve and soften the aesthetic character of large expanses of paved surfaces typical of parking lots.
- Maximize infiltration, biotreatment and stormwater runoff attenuation.
- Encourage surface runoff in diffuse and non-channelized flow as it leaves paved parking surfaces.

Considerations:

- Parking facilities should be designed so that drainage areas can be sized to optimize the function of best management practices selected for stormwater management
- Closed drainage systems should be limited to underground connections such as pipes and culverts between open, stormwater management components.
- Parking lot median strips can incorporate features such as bioswales, vegetated swales and bio-retention as part of their designs.
- The use of permeable pavers is encouraged to enhance infiltration, biotreatment and stormwater storage.

- Supplemental plugs of native perennial/forbs/grasses selected from Low-profile Prairie Mix # 4 may be installed to provide immediate landscape cover for color and interest.
- Selected ornamental plantings can be installed in islands and/or at the ends of median strips to provide the designer an opportunity to use plants that have longer bloom times. In addition, these plants can be used to blend the native landscape with the more conventional landscape that may be used around a building’s foundation.

Design Standards:

- Encourage parking to be located in the side or rear yard, rather than the front yard.
- Maintain the required perimeter yard setback for vehicular use areas along any public street.
- Plant low-profile prairie, interspersed with overstory and intermediary trees (in clusters with densities equivalent to 1 tree per 40 lineal feet) to buffer views of parking areas from public rights-of-way (see Section V (a), Perimeter Yards, above)
- Install segmented curb along the perimeter of all parking areas and along the edge of stormwater based island treatments (see Figure V-5). This will allow stormwater to be diffused as it passes from paved areas into prairie plantings or stormwater facilities.
- Maintain five-foot long breaks in the curb every 13 feet. These breaks should occur between parking spaces, where possible (see Figure V-5).

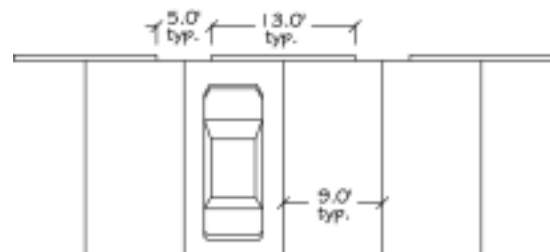

Figure V-5: Use segmented curb to diffuse stormwater from parking lot where it flows to adjacent landscaping

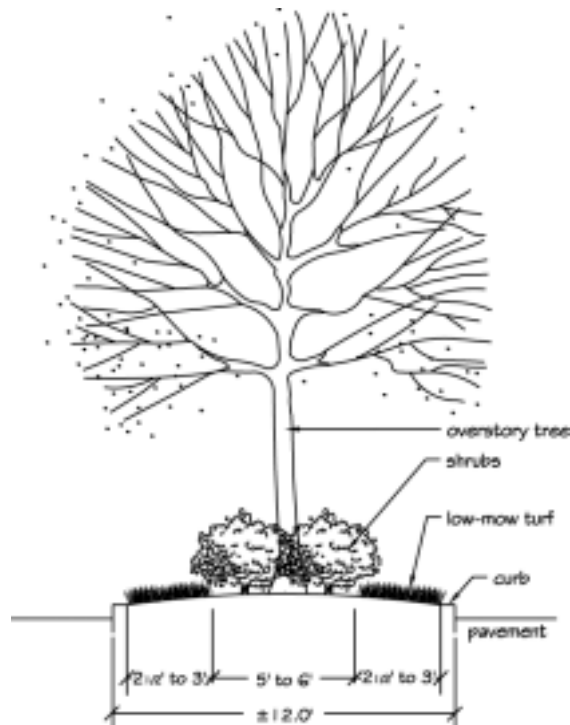

Figure V-6: Parking lot island or median strip planted with overstory tree, shrubs or perennials, and low-mow turf edge

- Design non-stormwater functioning parking lot islands or median strips so that they are:
 - At least 12 feet wide from outside face of the curb.
 - Include a two- to three-foot wide strip of low-mow turf along the inside of the curb.
- Plant islands or median strips that are not used for stormwater storage or treatment with approved groundcover, shrubs and overstory trees (see Figure V-6).
- Consider placing stormwater management facilities in parking lot islands or median strips. Where such facilities are proposed, follow guidelines developed for bioswales, bioretention areas, vegetated swales or other BMPs identified in Section V (g)

Planting Recommendations:

Components	Plant Community	Design Standards
Non-Stormwater Based Islands 2' Back of Curb Center of Island	Low-Mow Turf Overstory Trees, Woody Plant List # 2 Shrubs, Woody Plant List # 2 <i>OR</i> Perennials	Seed: 5 lbs. per 1000 s.f. 3" caliper, 1 tree per 40 lineal feet 24" height 1 gallon containers
Stormwater Based Islands Vegetated Swales Bioswale Bioretention		*See Section V(g)(1) *See Section V(g)(2) *See Section V(g)(4)
* Incorporate segmented curb to encourage diffuse flow		

Section V (e) – Location and Screening of Loading Facilities, Outdoor Storage, and Trash Containers and Compactors

Loading areas include truck loading docks and associated paved areas used to maneuver or park semi-trailer trucks for the purposes of delivering or receiving materials, supplies or merchandise. Given that these are areas of high activity, and can extend for long distances along a building facade, landscaping that softens views and interrupts the continuous view of trucks is required.

Outdoor storage areas are expected to be a common and prominent use within the Calumet Area. Equipment, materials, supplies and products awaiting transit are frequently stored in visible exterior locations. Fencing may be installed for security. The visual impact of outdoor storage areas can be improved through the establishment of intermittent landscaping intended to soften, screen and interrupt views.

Trash containers, trash compactors and other outdoor facilities for the routine storage of refuse prior to disposal require screening for aesthetic purposes. Although landscaping is recommended in conjunction with all trash and refuse areas, landscaping and other screening is specifically required for facilities located within public view.

These guidelines apply to front, corner side and rear yards facing public rights-of-way and waterways.

Design Objectives:

- Interrupt, soften and screen views of truck docks, storage areas and trash facilities along public rights-of-way.
- Maximize on-site stormwater management.
- Develop multi-level landscape screening, with a ground cover of grasses and forbs, a mid-layer of shrubs, and both overstory and intermediary trees.

Considerations:

- Loading can be located in the front, corner, side or rear yard, provided the required minimum 20-foot setback (perimeter yard) is maintained (See Figure V-7).

- The use of permeable pavers is encouraged to enhance infiltration, biotreatment and stormwater storage.
- Evergreen shrubs and trees are not used for screening, since they are not compatible with the native prairie theme established for the area.
- Screen plantings are not required in rear and side yards that do not abut a public right-of-way.
- Screening of these areas enhances the aesthetics of the Calumet Area. Such screening is required only in those areas that are along a public street or waterway.
- Integrate the placement of security fencing into the landscape so that it is not the dominant feature.
- Where possible, locate trash facilities in areas that are not visible from streets, waterways or parking lots.

Design Standards:

- Maintain the perimeter yards required for paved surfaces, which is 20 feet except in those areas that are located along Lake Calumet or the Calumet River (see Section V (a), Perimeter Yards, above).
- Install a continuous planting mix of trees, understory trees, shrubs, and groundcovers in a zone that is at least 20 feet wide to soften and screen views of loading docks, storage areas or trash facilities along a public right-of-way. Refer to the planting recommendations that follow for the appropriate mix and density of landscaping. Landscaping does not have to be contiguous all along the right-of-way.
- Plant required landscaping along the full extent of loading areas, plus another 50 feet beyond these areas (in each direction) to maximize screening (see Figure V-7).

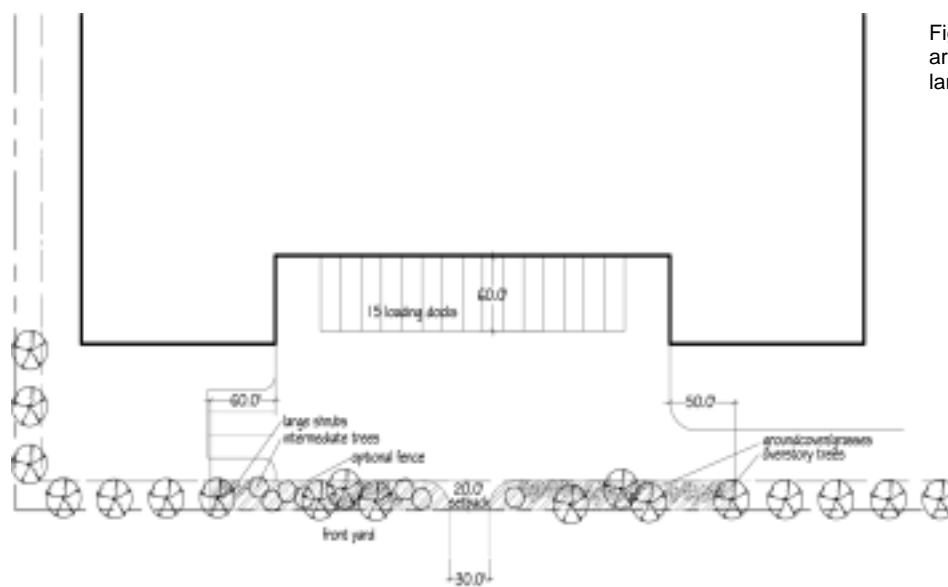

Figure V-7: Screen loading docks that are visible from public rights-of-way with landscaping

- Grade all areas to drain surface runoff into the stormwater management system using one or more of the best management practices identified in this manual.
- Install landscaping around the trash enclosure to help it blend into the overall landscape.

Planting Recommendations for Loading Areas:

Components	Plant Community	Design Standards
Screening	Overstory Trees, Woody Plant List #2 or #3 Intermediate Trees, Woody Plant List #2 or #3 Deciduous Shrubs, Woody Plant List #2 or #3 Low-Profile Prairie, Mix #2 or #7	3" caliper, 2 trees per 1000 s.f. 2" caliper, 4.5 trees per 1000 s.f. 30" height, 34 per 100 l.f., 16 per 1000 s.f. Seed: 41.38 lbs. per acre Plugs: 50 plants per acre in 2.5" containers @ 24" o.c. (avg.)
Mulch	Hardwood Mulch	3" depth minimum

Planting Recommendations for Outdoor Storage and Trash Facilities:

Components	Plant Community	Design Standards
Screening	Overstory Trees, Woody Plant List # 2 or # 3 Intermediate Trees, Woody Plant List #2 or #3 Deciduous Shrubs, Woody Plant List #2 or #3 Low-Profile Prairie, Mix # 7	3" caliper, 2 trees per 2000 s.f. 2" caliper, 2 trees per 2000 s.f. 30" height, 28 per 1000 s.f. Plugs: 50 per acre in 2.5" containers @ 24" o.c. (avg.)
Mulch	Hardwood Mulch	3" depth, minimum

Section V (f) – Building Foundation Plantings

The land close to buildings is the land that will see the most use by workers and visitors. This is the area people walk through every day. This is the most likely location for someone to step out for a breath of fresh air or a cigarette, or where someone might eat lunch if a bench is provided. Because of the intensive human use around buildings, designers may favor a more cultivated look with mowed grass and ornamental plantings.

Though there is flexibility with plant choices and hard-surface decisions, it's important that the landscape unifies the building with its surroundings and with the natural aesthetic of the Calumet Area. As is the case elsewhere, native plants or cultivars of natives are favored. Taller trees and shrubs will provide shade and cooling. Shrubs and trees can serve as a barrier to wind, as well as provide additional visual texture and interest to buildings. Shrubs and flowering perennials bring color and texture to the exterior views. The appropriate size and extent of landscaping will depend on the scale of the structures, with larger, taller structures needing a wider and taller massing of plant material than will be required for smaller buildings.

Design Objectives:

- Enhance the appearance of building facades and entryways visible from public rights-of-way.
- Create a diversity of color, structure and texture consistent with the prairie landscape theme.
- Create an attractive environment amenable to human use.

Considerations:

- Allow the use of selected ornamental plants to provide a more traditional landscape in front of buildings.

- The width of required foundation areas changes to be compatible with the height of the proposed building.
- Landscape foundation areas are not required for side and rear building facades not facing public rights-of-way, if they also adjoin paved surfaces such as parking lots, loading docks etc. Where they are provided, however, they should be eight feet wide.



Figure V-8: Provide 8 feet of planting for buildings less than 14 feet tall

Design Standards:

- Provide foundation landscaping along all facades that face public rights-of-way.
- Maintain the distances from the building foundation listed below as a minimum (excluding all impervious surfaces such as walks, drives, parking areas etc. See Figures V-8 through V-10).

Average Building Height	Minimum Width
< 14 feet	8 feet
> 14 feet but < 35 feet	12 feet
> 35 feet but < 50 feet	18 feet
> 50 feet	Add 3.5 feet for each additional 10 feet of height

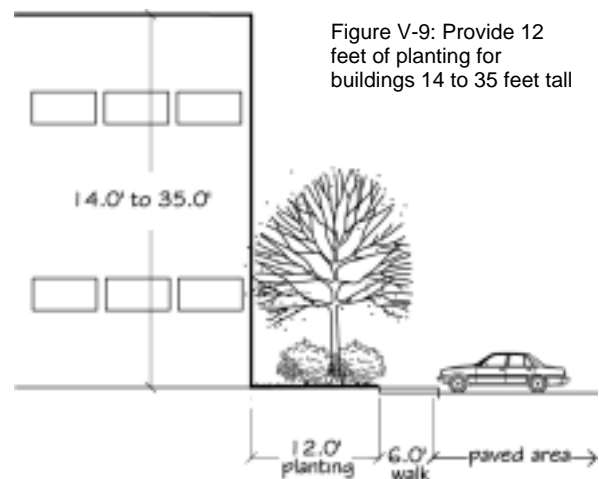

Figure V-9: Provide 12 feet of planting for buildings 14 to 35 feet tall

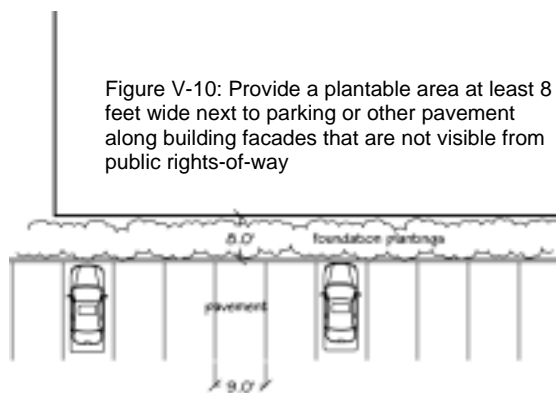

Figure V-10: Provide a plantable area at least 8 feet wide next to parking or other pavement along building facades that are not visible from public rights-of-way

- Provide at least eight feet of landscaping (excluding walks and driveways) along side and rear building facades that do not face a public right-of-way, where pavement adjoins buildings and foundation plantings are provided (see Figure V-10).

- Provide at least five feet of landscaping (excluding walks and driveways) along side and rear building facades that do not face a public right-of-way, where natural landscaping adjoins buildings and foundation plantings are provided.

Planting Recommendations:

Any plant on the general planting list included in Appendix B may be used in this application, subject to site-specific conditions.

Section V (g) – Stormwater Systems - Best Management Practices

Why Use Best Management Practices (BMPs):

The design guidelines specify many times that BMPs are to be utilized in various features of sites. This area of BMPs for stormwater management is where guidelines for the Calumet Area diverge most strongly from conventional industrial development. Though this section describes these practices, DPD staff is willing to work with developers and designers to further explain and to assist in deciding what options may be appropriate for a given site.

The BMPs that follow were developed to encourage infiltration where contamination is not a problem, maximize stormwater retention, facilitate conveyance between properties, and enhance water quality in the Calumet Area. Landscaping with native plants serves an important role in these functions by:

- Slowing runoff from developed areas.
- Facilitating infiltration.
- Assisting in the uptake of moisture through transpiration.
- Assimilating nutrients.
- Filtering out particulates.
- Stabilization channels, slopes and shorelines.

Selection of Plant Materials:

The land selected for implementation of stormwater facilities is likely to be subjected to a wide range of conditions, from heavy saturation to intermittent drought. Within the landscape of stormwater facilities, the design professional will be faced with the challenge of anticipating long-term conditions of soil moisture, frequency and duration of inundation, as well as water quality (e.g., salinity, turbidity and nutrient loading.)

Plant lists provided in these guidelines were developed for typical conditions. The design professional is encouraged to evaluate specific site conditions for each project and make adjustments using Appendix E as appropriate.

Section V (g)(1) — Vegetated Swales:

A vegetated swale is an open system that is used to slow runoff and filter sediments and pollutants. It is used instead of conventional piping to contain and convey stormwater. Depending on the depth of the water table, the swale may be wet, wet-mesic or well-drained. On-line detention can be augmented by using check dams. Maximum efficiency for water quality enhancement can be achieved by lengthening the channel and/or minimizing its gradient.

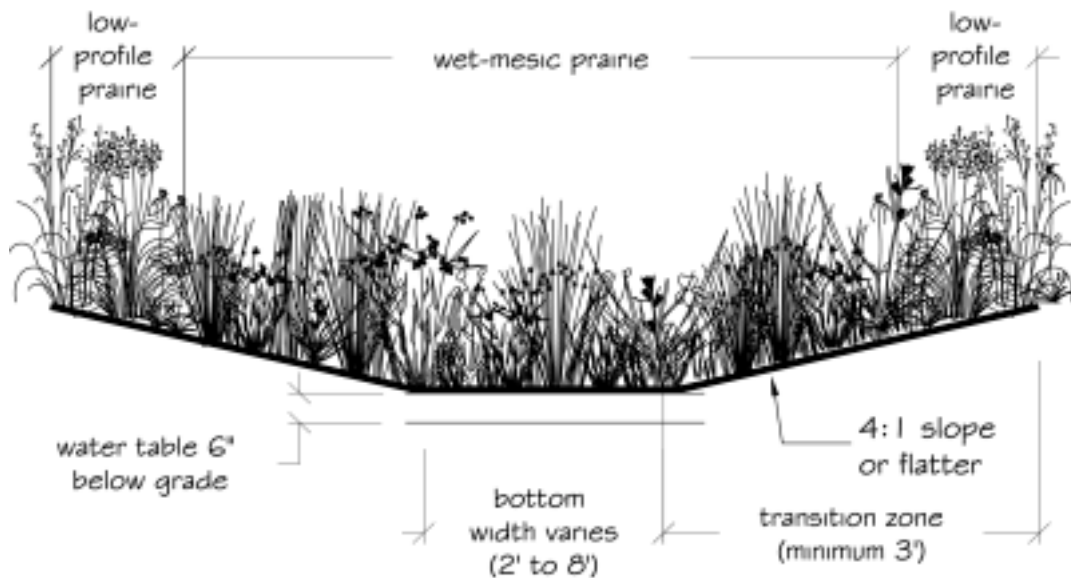

Figure V-11: Design characteristics of a vegetated swale

Design Objectives:

- Slow conveyance of stormwater runoff.
- Facilitate the removal of pollutants and the assimilation of organic nutrients by vegetation.
- Encourage surface water infiltration (where soils permit).
- Provide an aesthetically pleasing landscape feature.

Considerations:

- Vegetated swales should be at least 20 feet wide, and designed with slopes that do not exceed 4:1 (see Figure V-11).
- The design of the landscape within a vegetated swale will depend upon:
 - Its location and function.
 - Soil permeability.
 - The depth to water table.
- An erosion control blanket will be required for slopes that are steeper than 5:1. Slopes that are 5:1 or less can be stabilized by vegetation and mulch (see Section VI, Specifications).
- The water level in the swale will fluctuate. Plant mixes presented below have been developed to tolerate the two-year and ten-year storm events.

Design Standards:

- Develop swales with slopes that are 4:1 or flatter.
- Install mixes in appropriate zones (see Figure V-11).

Planting Recommendations:

Components	Plant Community	Design Standards
Well-Drained Swale	Low-Profile Prairie, Mix #3	Seed: 47.7 lbs. per acre Plugs: 50.0 per acre, 18" o.c. (avg.)
Wet-Mesic Swale Slopes above 2-year event	Low-Profile Prairie, Mix #3	Seed: 47.7 lbs. per acre Plugs: 50.0 per acre, 18" o.c. (avg.)
Bottom	Wet-Mesic Prairie, Mix #2	Seed: 39.7 lbs. per acre Plugs: 4850 per acre, 18" o.c. (avg.)
Wet Swale: Slopes above 2-year event	Low-Profile Prairie, Mix #3	Seed: 47.7 lbs. per acre Plugs: 50.0 per acre, 18" o.c. (avg.)
Waterline (NWL to 2-year event)	Wet-Mesic Prairie, Mix #2	Seed: 39.7 lbs. per acre Plugs: 4850 per acre, 18" o.c. (avg.)
Bottom (NWL to 6" below NWL)	Emergent Marsh, Mix #3	Seed: 8.8 lbs. per acre Plugs: 4825 per acre, 18" o.c. (avg.)

Section V (g)(2) – Bioswales:

Bioswales are recommended for use in parking lots as a way to replace curbed, landscaped medians with an option that assists in stormwater management. A bioswale is a lightly excavated swale where the grade is a foot lower than surrounding pavement. Surface water enters the swale via openings in the curb, and then flows through a series of short pools created by low check dams. Water drains into a stormwater inlet and then flows through underground pipe to the next segment of the stormwater system. Bioswales can improve water quality through the removal of sediments and the assimilation of nutrients.

A bioswale can be planted with trees for shade, and with low-growing prairie plants that tolerate road salt. Plant choices may include decorative native grasses such as little bluestem and prairie dropseed, as well as flowers such as brilliantly orange butterflyweed or purple spiderwort. This creates an attractive first-impression for a business facility, as well as being a component of a stormwater management system.

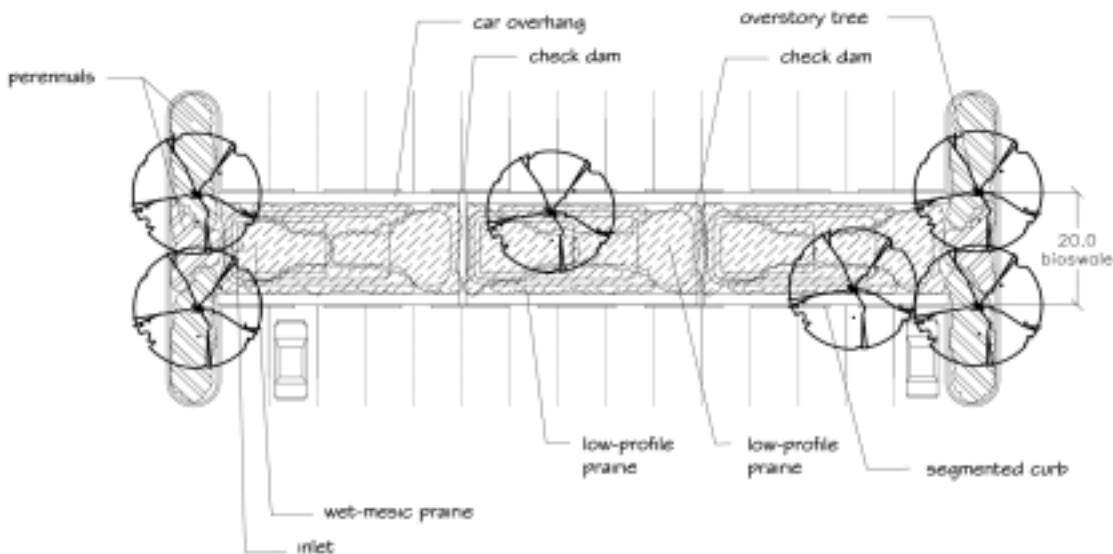

Figure V-12: Typical bioswale with segmented curb and check dam

Plants selected need to be adaptable to varying soil moisture regimens, depending on their location in the system. The success of a bioswale can be enhanced by seasonal flushing of salts and de-icing chemicals. This reduces the effects of accumulated salts or de-icing chemicals on plants in the spring that could stunt growth, or otherwise damage or destroy the landscape.

Design Objectives:

- Encourage the settling of particulates and associated pollutants from parking lots.
- Offer the opportunity for infiltration and the assimilation of nutrients by native plants.
- Help store and modulate conveyance of stormwater.
- Provide an aesthetically pleasing amenity in open parking lots that introduces seasonal color and interest through the planting of native flowering plants and perennials on the ends of islands.

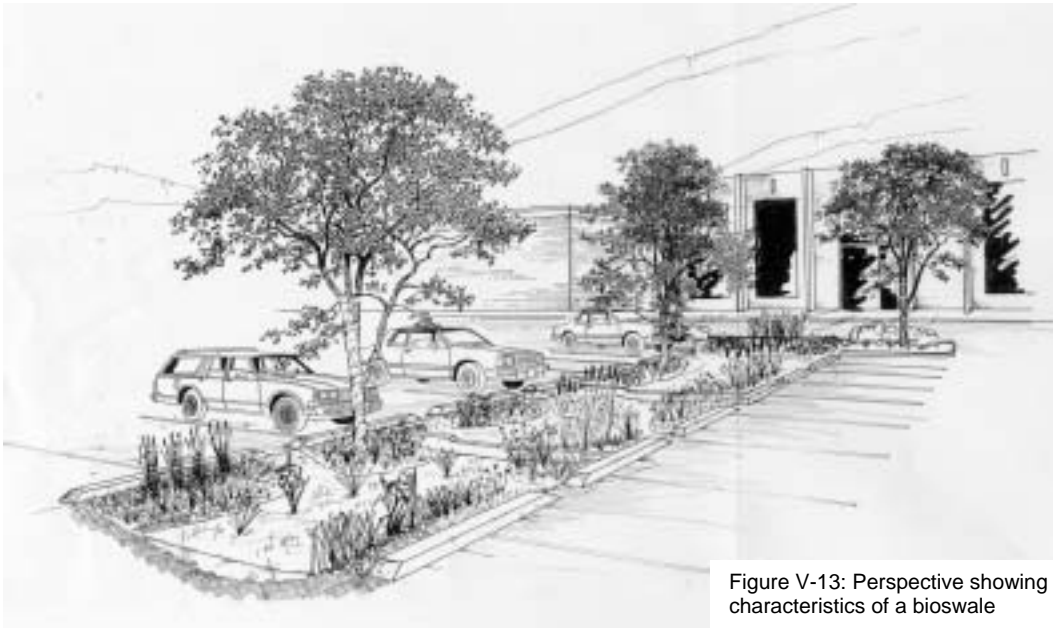

Figure V-13: Perspective showing visual characteristics of a bioswale

Considerations:

- Snow should not be piled within these swales, but placed in other areas of the parking lots to minimize the leaching of salt or other chemicals into the bioswales.
- Sand or de-icing chemicals, such as calcium chloride, should be used instead of salt to maximize the success of the landscaping in these swales.
- A bioswale needs to have access to a water hookup or have an irrigation system installed to flush out chemical de-icing agents or salts in early spring.

Design Standards:

- Provide 20-foot wide bioswales within alternating parking modules (one bioswale every three rows.)
- Construct the bioswale with side slopes that are 3:1 or flatter.

- Create check dams with soil or other material (i.e., concrete, boulders, or masonry interlocking retaining wall system) every 50 feet.
- Construct a series of 9’ long, 6” segmented barrier curb with 24” openings, along the length of the bioswale, between each segment.
- Install 24” of low-mow turf or other material acceptable to the City on the inside edge of the curbs to accommodate car overhang.
- Select plantings for conditions typical for each zone (i.e., dry, wet and fluctuating between dry and wet) from the plant lists identified below. Use native plants in the swale and, where possible, on the ends of each island.
- Use horticultural varieties of native plants on islands for longer-bloom times and more intense color. However, the designer is limited to the perennials list included in Appendix B for end islands of bioswales, to ensure landscapes are blended (native and ornamental).
- Install an erosion control blanket in the swale while vegetation is established.

Recommended Plantings:

Components	Plant Community	Design
Upper Slopes (next to pavement)	Low Profile Prairie #2 Overstory Trees, Woody Plant List #2	Plugs: 405/900 sq. ft., 18” o.c. (avg.) 3” caliper, min. (6’ branch ht.) 1 tree/45 lineal feet
Channel (below check-dam)	Low Profile Prairie #1	Plugs: 405/900 sq. ft., 18” o.c. (avg.)
Channel (above check-dam)	Wet- Mesic Prairie, Mix #5	Plugs: 405/900 sq. ft., 18” o.c. (avg.)
Island Termini	Perennials	1600/25 sq. ft., gal.containers 15” o.c. (avg.)
	Overstory Trees, Woody Plant List #2	3” caliper, min (6’ branch ht.) 2 trees per island terminus

Section V (g)(3) — Permeable Pavers:

Permeable pavers are interlocking concrete blocks set in a compacted sand or gravel base. The bed allows absorption of rainwater. When laid properly, with an appropriate depth of gravel, pavers can handle weight loads equal to or greater than those of asphalt or other conventional impermeable surfaces.

They can be used in parking lots, loading areas, and outdoor storage areas where no chemicals or other materials hazardous to the environment are stored. Their use is appropriate where a hard, paved surface is required and reducing stormwater runoff is desirable.

Pavers form a tight surface with narrow joints separating the pavers, and structured openings that are filled with permeable material, such as gravel. Approximately 10 to 12 percent of the surface area remains permeable, allowing rainwater to drain through the paved surface and into the subgrade material below. Depending on the nature of the soil on the site, water may infiltrate and contribute to groundwater recharge, or it may be discharged into other stormwater management facilities via underground drains.

The use of permeable pavers reduces runoff, providing some storage, and it improves water quality. Water that is discharged into other swales, ponds or basins is cooler and microbial action within the aggregate subgrade helps enhance water quality. Permeable pavers are marketed under several different names, but should not be confused with permeable pavements, which require resurfacing.

Permeable pavers can be:

- Plowed without damage to the paver surface.
- Painted to differentiate parking spaces.
- Color-coordinated to identify pedestrian walkways, parking spaces, or drive aisles.
- Used instead of concrete for private walks.
- Installed along the edges of drive aisles or parking lots to allow runoff or rain water to infiltrate into the ground.

Design Objectives:

- Provide a solid paved surface with high permeability for surface water (see Figure V-16).
- Create an aesthetic amenity on parking, loading, and driving surfaces.

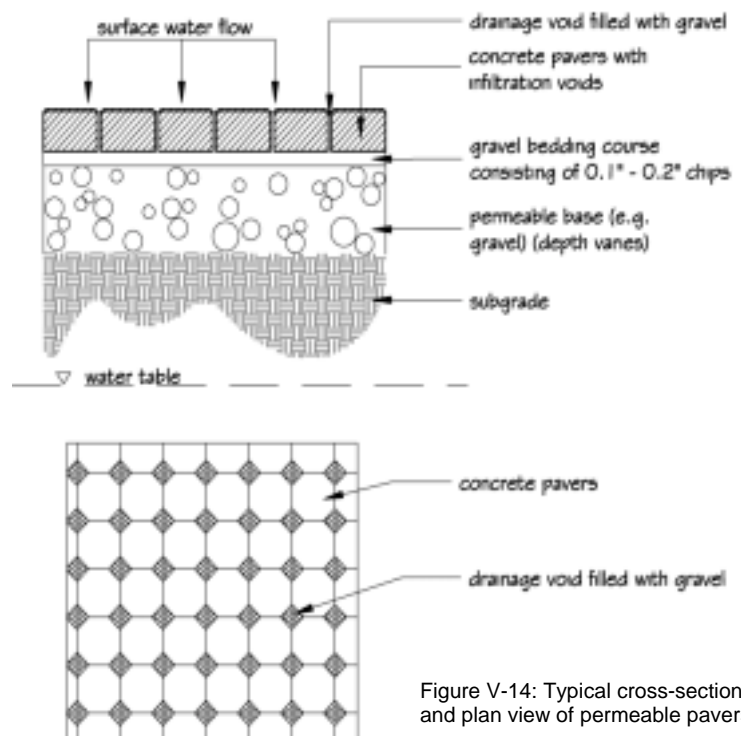

Figure V-14: Typical cross-section and plan view of permeable pavers

- Offer opportunities for attractively distinguishing between functional areas and pedestrian ways, drive aisles and parking lots.

Considerations:

- Permeable pavers cost more to install than traditional asphalt pavements, though they last longer and do not require resurfacing.
- They require regular sweeping to remove debris from openings.
- They require periodic replacement or cleaning of the gravel filters to remove silt that can obstruct infiltration of water into the ground.

Design Standards:

- Consult paving manufacture for installation and maintenance specifications.
- Install pavers mechanically to achieve cost competitiveness with asphalt.

Section V (g)(4) – Bioretention Basin

A bioretention area is a depressional stormwater management facility that uses a conditioned soil, mulch and plant matrix to collect, and infiltrate stormwater (see Figure V-15). It uses the substrate and its microbial action to filter and break down or assimilate pollutants. Stormwater is routed to or flows overland through a vegetated strip to the basin, then enters a shallow basin consisting of a prepared planting bed, organic mulch and woody and herbaceous plant species. Water is detained, passing slowly through the soil medium and allowing the physical and biological processes in the facility to enhance water quality before discharge.

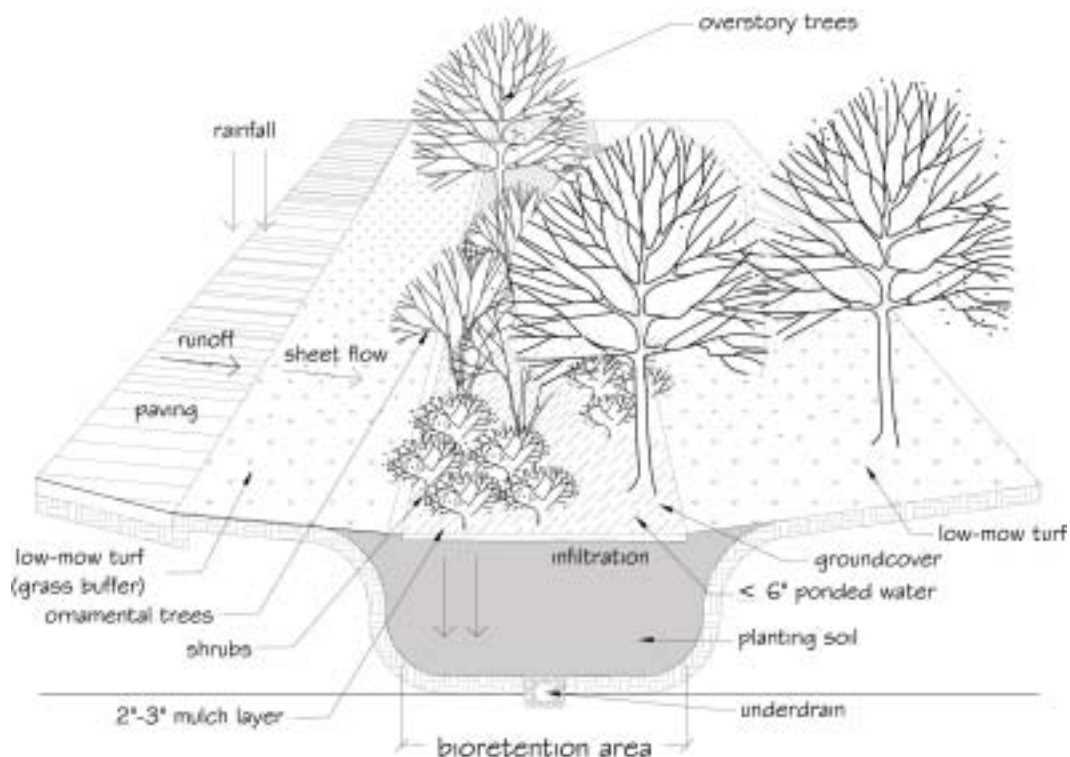

Figure V-15: Typical cross-section of a bioretention facility

Design Objectives:

- Establish a grass strip to intercept surface runoff entering the basin, reducing flow velocities, and filtering out sediments.
- Construct a deep, planting soil mixture that supports desirable vegetation and permits infiltration to subgrade or underdrain.
- Create a terrestrial forest ecosystem consisting of canopy and understory trees, shrubs and ground cover, planted in a shallow, mulch layer.

Considerations:

- The use of this type of facility is not recommended on slopes greater than 5:1.
- Special attention to erosion and sediment control is critical for those areas tributary to the basin in order to prevent silt loads from clogging the basin.
- A bioretention basin can be established either on-line or off-line of the stormwater system. To prevent clogging, pre-treatment (vegetated filter strips, bioswales, etc.) may be required of the first flush.
- Basin size is determined by drainage area and runoff characteristics.
- Multiple bioretention basins may be required for larger drainage areas.

Design Standards:

- Design the basin so that:
 - A grassed buffer strip intercepts overland flow from paved surfaces.
 - Its maximum ponding depth is six inches.
 - Standing water at or near the surface should be eliminated within 72 hours to avoid mosquito proliferation.
- Use the following specifications for planting soil:
 - Soil should be two to three feet deep and four inches deeper than the largest root ball.
 - It should be sandy loam, loamy sand or loam texture with clay content ranging from 10 to 25 percent and a sand content of approximately 50 percent.
 - Planting soil should have infiltration rates of 0.5 inches per hour or greater.
 - The soil pH should be between 5.5 and 6.5, with approximately 1.3 to 3 percent organic content.
- Add a 2 to 3 inch layer of fine shredded mulch as a top layer in the basin.
- Vegetate the bioretention facility to create a terrestrial forest community, with a minimum of three species of trees and a shrub to tree ratio of 2:1 to 3:1.
- Install perforated pipe underdrains in the facility, unless it is constructed in sandy soils.

- The shape of the basin should be a curved configuration following natural contours.
- Final design specifications to be determined by the Department of Water Management.

Planting Recommendations:

Components	Plant Community	Design Standards
Vegetated Buffer Strip	Low-Mow Turf <i>OR</i> Low-Profile Prairie Mix # 7	Seed: 5 lbs. per 1000 s.f. Plugs: 50 per acre in 2.5" containers @ 24" o.c. (avg.)
Basin	Overstory Trees, Woody Plant List #2 or #3 Intermediate Trees, Woody Plant List #1 or #4 Deciduous Shrubs, Woody Plant List #1 or #4	3" caliper, 1 tree per 1000 s.f. 6' ft. B&B; 3 trees per 1000 s.f. 30" ht., 10 per 1000 s.f.
Groundcover		Seeds: 44.57 lbs. per acre
Basin Slopes	Low-Profile Prairie # 2	Seed: 41.38 lbs. per acre Plugs: 50 per acre in 2.5" containers @ 24" o.c. (avg.)
Basin Bottom	Wet-Mesic Prairie Mix # 5	Plugs: 225 per acre in 2.5" containers @ 24" o.c. (avg.)

Section V (g)(5) – Stormwater Wetland

Of the wetland basin types listed in Table 2, Stormwater wetlands are the preferred option in the Calumet area as they are designed specifically to receive and treat stormwater runoff (see Figures V-16 and V-17). Water quality improvement is achieved through a combination of settling, microbial action and pollutant assimilation by wetland plants. Stormwater wetlands are designed to accommodate lower water quality and frequent fluctuations in water level. They can be an aesthetic feature, offering wildlife habitat as well as functioning as part of the stormwater management system.

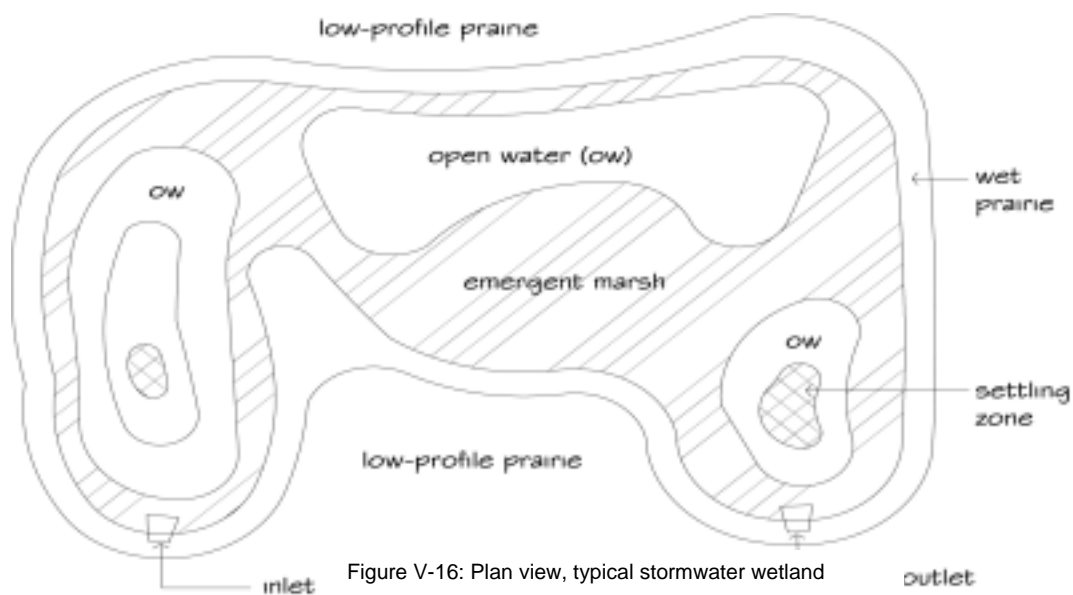
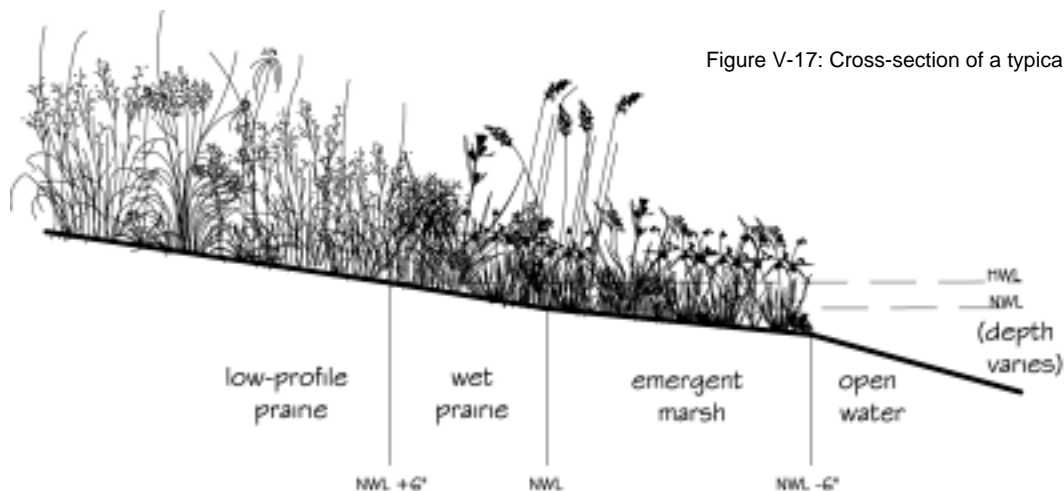

Figure V-16: Plan view, typical stormwater wetland

Design Objectives:

- Construct a wetland system that is capable of detaining the design storm.
- Design stormwater wetlands with natural, curvilinear configurations and contours, and avoid steep slopes and angular geometric shapes.
- Provide water quality enhancement to stormwater entering the wetland basin through a design that encourages the settling of particulates and biological assimilation of nutrients.
- Provide both upland and wetland habitat for wildlife.
- Create an aesthetic feature as part of the stormwater management system.
- Install native landscaping to minimize maintenance costs.

**Considerations:**

- Wetlands receiving high levels of pollutants should be separated from groundwater to avoid contamination.
- Maintaining appropriate normal water levels is most easily accomplished by using a controlled outlet, allowing excess water entering the basin to discharge downstream.
- Plant materials will need to be selected based on the anticipated hydrologic regimen of the specific basin and its associated moisture gradient.
- Shallow marsh communities may need to be protected from waterfowl through the use of net or wire mesh planting enclosures until such time as the plants become well established.

Design Standards:

- Route enough stormwater to the wetland basin to maintain a permanent pool.

- Design the wetland basin and discharge to permit water levels under the 10-year, 24-hour duration storm event to rise and return to near normal water level (NWL) within a 24-hour period.
- Establish a pretreatment forebay at the basin’s inlet, sized to hold approximately ten percent of the permanent pool volume.
- Provide access for periodic maintenance and silt removal as necessary from the forebay.
- Maintain a minimum length to width ratio of 1.5:1 for the main body of the wetland.
- Provide a wetland surface area that is at least one percent of drainage area.
- Maximize the distance between inlet and outlet to avoid short-circuiting of flows.
- Create variable planting depths throughout body of basin ranging from + 6 inches to - 6 inches from normal water level.
- Create deeper zone near outlet to permit additional settling of particulates.

Planting Recommendations:

Components	Plant Community	Design Standards
Top of Slope to 6" above NWL	Low-Profile Prairie, Mix # 2	Seed: 41.4 lbs. per acre Plugs: 50 per acre in 2.5" containers @ 24" o.c. (avg.)
6" above NWL to NWL	Wet-Prairie, Mix # 2	Seed: 43.4 lbs. per acre
NWL to 6" below NWL	Emergent Marsh, Mix # 2	Seed: 5.6 lbs. per acre Plugs: 4000 per acre in 2.5" containers @ 24" o.c. (avg.)

Section V (g)(6) – Vegetated Filter Strip

A vegetated filter strip is a linear vegetated area separating an up-gradient pollution source or development from any adjacent water resources such as a waterway or perhaps a wetland on the Calumet Open Space Reserve (see Figure V-18). Vegetated filter strips intercept surface flow, filtering out a portion of the sediment load and increasing opportunities for infiltration.

Design Objectives:

- Filter out pollutants between developed areas of the site and wetland or surface water body.
- Ensure filter strip is fully vegetated (not spotty) to meet design objectives.

Considerations:

- To operate effectively, only sheet flow should pass through the filter strip.

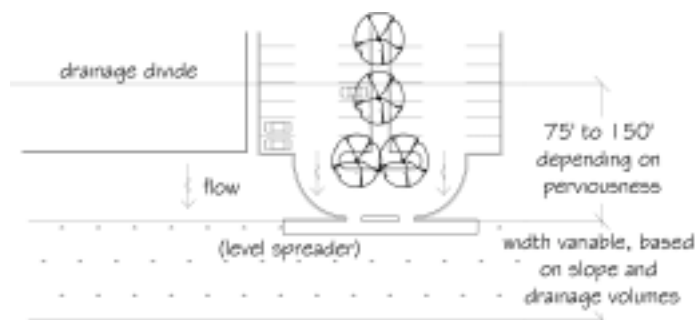

Figure V-18: Use a vegetated filter strip to filter out pollutants between a developed area and adjacent water body

- This feature is not appropriate where high velocities of surface runoff will occur.
- The use of a level spreader at the upper edge of the strip is recommended, because it can help maintain sheet flow (see Figures V-18 and V-19, next page).
- The water-quality enhancement functions of a vegetated filter strip are appreciably reduced on slopes of greater than ten percent.

Design Standards:

- Ensure that the drainage area is five acres or less.
- Use a level spreader at the upper edge of the strip to help maintain sheet flow.
- Design the filter strip so that the:
 - Length of the vegetated strip (perpendicular to flow) extends the entire length of the impervious surface from which stormwater originates.
 - Flow length (parallel to flow) of areas draining to a filter strip is no more than 75 feet for impervious areas and no more than 150 feet for pervious areas.
 - Optimum width is based on the water quality design storm (up to a 2-year storm event) and a hydraulic radius equal to a design flow depth of less than or equal to 0.5 inches.
 - Minimum width is 25 feet.
 - Slope is greater than one percent, but less than five percent.

Planting Recommendations:

Use one or more components as appropriate to site conditions:

Components	Plant Community	Design Standards
Groundcover	Low-Profile Prairie Mix # 4 OR	Seed: 47.7 lbs. per acre Plugs: 50 per acre in 2.5" containers @ 24" o.c. (avg.)
	Mesic Prairie Mix # 1 OR	Seed: 47.95 lbs. per acre Plugs: 50 per acre in 2.5" containers @ 24" o.c. (avg.)
	Mesic Prairie Mix # 2 OR	Seed: 47.95 lbs. per acre Plugs: 50 per acre in 2.5" containers @ 24" o.c. (avg.)
	Wet-Mesic Prairie Mix # 3 OR	Seed: 44.59 lbs. per acre Plugs: 50 per acre in 2.5" containers @ 24" o.c. (avg.)
	Wet-Mesic Prairie Mix # 4	Seed: 49.93 lbs. per acre Plugs: 100 per acre in 2.5" containers @ 24" o.c. (avg.)

Section V (g)(7) – Level Spreader:

A level spreader is a water management feature that assists in the interception and collection of moderately concentrated flows of surface runoff and disperses the runoff in a uniform manner to the adjoining landscape (see Figure V-19). Although not water quality enhancement features themselves,

level spreaders improve the effectiveness of other BMPs that depend on sheet flow to operate (e.g., vegetated filter strips). Level spreaders may be used at the edges of parking lots, loading areas, driveways or other discharge points where it is desirable for a point source discharge to be spread over a larger horizontal area. This feature consists of a deep, gravel-filled trench, running perpendicular to the direction of concentrated flow. Water entering the trench spreads evenly along its axis before it infiltrates into surrounding soils.

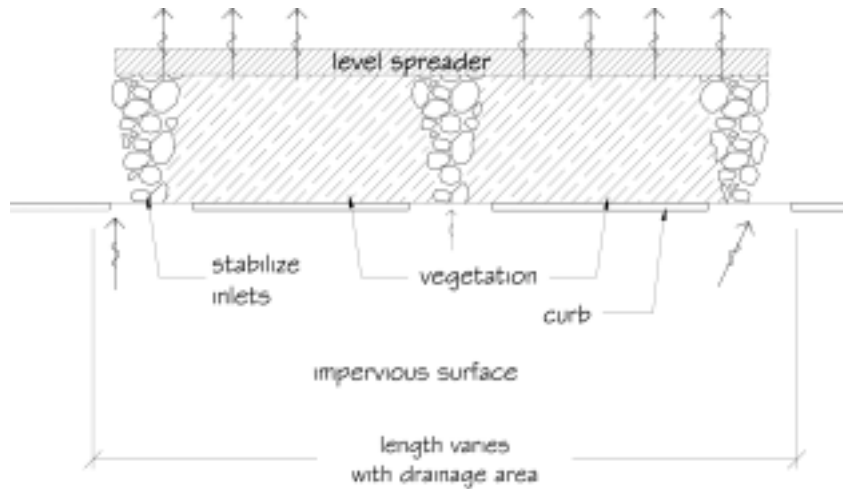

Design Objectives:

- Establish a linear trench with the capacity and porosity to capture, disperse and discharge surface runoff.
- Maximize design compatibility with surrounding landscape by planting trees and shrubs to soften exposure of linear aggregate.

Figure V-19: Use a level spreader to convert concentrated runoff to diffuse flow

CONSIDERATIONS:

- The level spreader must be absolutely level to avoid ponding and re-concentration of flows.
- Areas tributary to level spreaders should be stabilized to avoid erosion.
- Flows to the level spreader should be free of sediments.
- Level spreaders must be maintained at a level elevation to avoid the re-concentration of flows and the creation of gullies. If gullies start to develop, they must be repaired immediately.

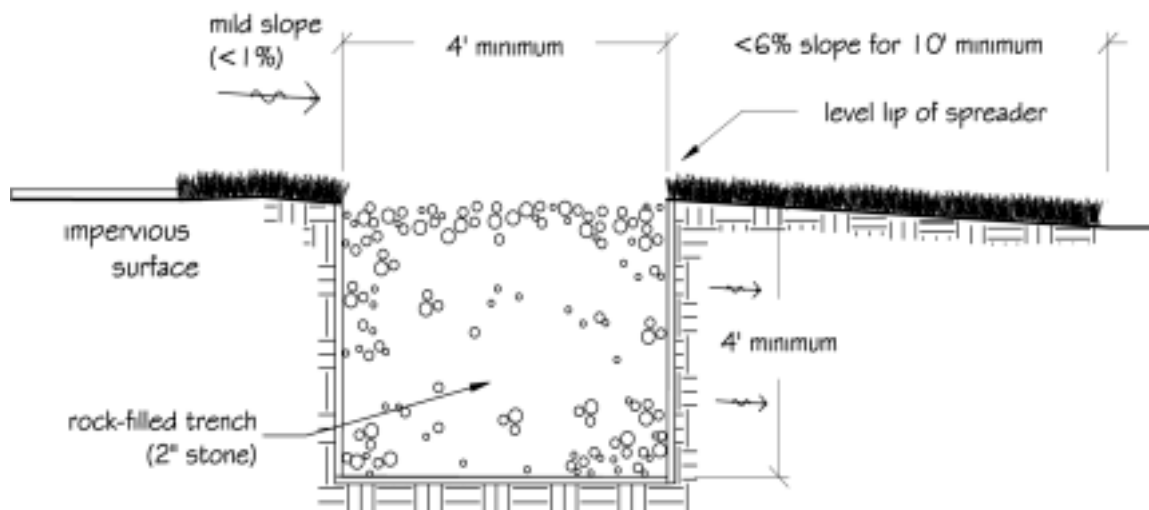

Figure V-20: Cross-section of a typical level spreader

Design Standards:

- Base the length of a level spreader on a 10-year design flow, adjusting for the drainage area as follows:

Drainage Area (acres)	Minimum Length (feet)
1	10
2	10
3	15
4	18
5	20

- Design the slopes that lead to the level spreader as follows:
 - The slope upgradient from the level spreader should be less than 1 percent for at least 20 feet; and
 - The slope downgradient should be 6 percent or less.

Section V (h) – Green Roof

A green roof is a very lightweight, contemporary version of a sod roof (Figure V-21). The use of a green roof can provide benefits not available from regular construction. These benefits include:

- Improved thermal insulation for buildings.
- Reduced heating and cooling requirements.
- Increased life expectancy of roofing membrane from better protection from mechanical damage, ultra-violet rays, hail, and extreme temperature differences.
- Reduced heat absorbtion.
- Sound insulation
- Stormwater attenuation and the desynchronization of peak run-off periods (Absorbs up to 75 percent of rain falling on it, depending on rainfall intensity).
- Natural production of oxygen and the consumption of carbon monoxide

Unlike conventional roof gardens that require substantial financial and energy expenditures to import large quantities of soil, plant and cultivate shrubs and trees, and structurally modify buildings to increase load bearing, eco-roofs are relatively inexpensive and can generally be retrofitted to existing buildings. With this concept, the roof is covered with a lightweight growing medium, generally 2” thick. This medium, called substrate, supports an herbaceous layer that provides the thermal and hydrological benefits. Green roofs can be installed on roofs up to a 6:12 pitch. Little to no fertilization or irrigation is necessary in temperate climates.

Design Objectives:

- Create a lightweight, rooftop, plantable medium capable of supporting a vegetated groundcover.
- Establish a low-maintenance; weed-free plant community with extensive root structure capable of rapidly transpiring accumulated rainfall.
- Limit extent and weight of entire structure to avoid costly expenditures for added structural reinforcement

Considerations:

- Avoid woody plant materials that will add additional weight and maintenance.
- Rely on average rainfall for adequate moisture except during extended periods of drought.
- Collect and reuse roof runoff for rooftop irrigation when required.
- Use structural techniques on sloped roofs as required to hold planting medium in place.
- Do not make planting medium too fertile, since this will encourage the growth of invasive species.
- Roof access for installation and long term serviceability of plants.
- Evaluate performance and goal for roof to determine what type of system

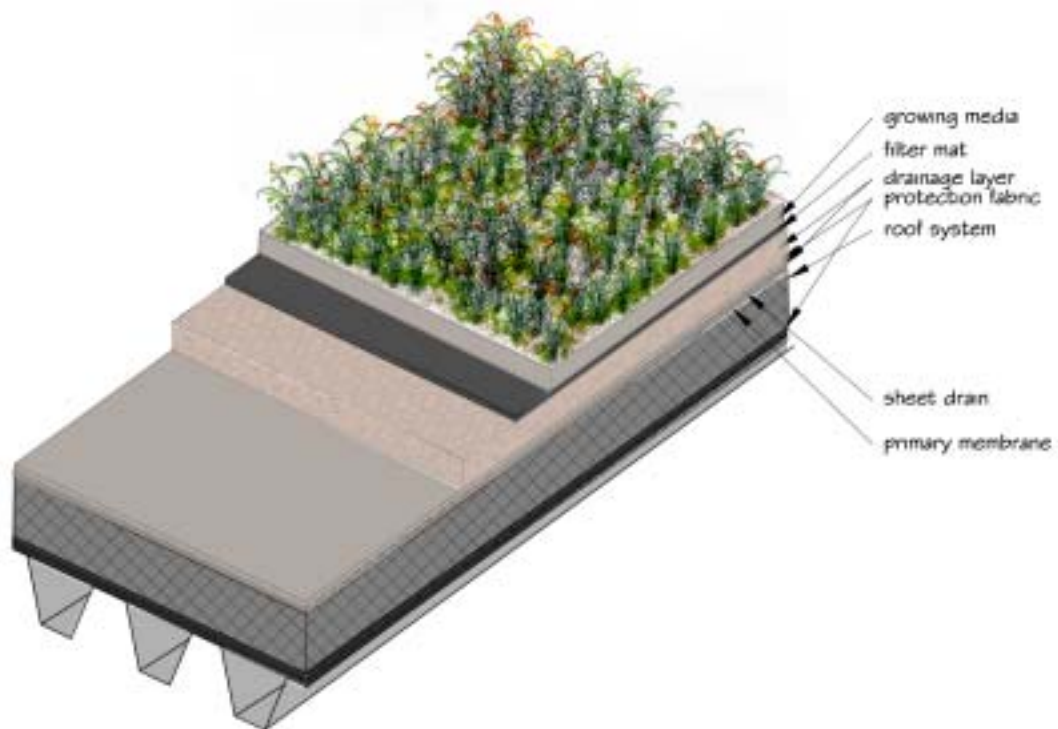

Figure V-21: Green Roof cross section.

Design Standards:

- Install a waterproof membrane, a layer of insulation, a drainage layer and a growing medium on the roof.
- Provide plantable medium only to a depth necessary to support the selected plant community.
- Use plantings with shallow/lateral, but extensive root systems-no top roots.
- Select plant species with wind tolerance and resistance to drought.

Recommended Plantings:

Sedum spp. can be successfully used on a green roof. However, a wide variety of plants can be specified for use besides sedum. Refer to "A Guide to Rooftop Gardening" published by the City of Chicago for further information.

Section V (i) – Lake and River Shorelines

River and shoreline landscape treatments are an important and integral part of site development issues in the Calumet Area. Functionally the Calumet River and Lake Calumet serve as corridors for commerce, permitting the movement of materials and goods by waterway to and from Great Lakes transportation routes. For purposes of these guidelines, a distinction is made between the "River Dependent" and "River Non-Dependent" water's edge.

Specific areas where industrial sites are used for access to these waterways are considered "River Dependent" and priority is given to allowing loading and unloading operations to directly access the waterway. Shorelines in these areas are typically stabilized through the construction of a retaining wall and its associated hardscape. Where property is developed adjacent to water bodies, but the use does not require access to the waterways, these zones are considered "River Non-Dependent." Here, natural functions will take priority, emphasizing slope stabilization, interception of surface runoff and creation of a viable riparian zone supportive of wildlife.

In the land areas adjacent to Indian Creek, transportation access is not recommended. Landscape emphasis is therefore on the preservation and enhancement of the natural values of riparian habitats. Riparian functions include slope stability, water temperature modulation through shading by streamside vegetation, infiltration of surface runoff, habitat for wildlife, and the introduction of energy into the aquatic system in the form of terrestrial biomass.

Design Objectives:

- Stabilize riverbanks and shorelines to minimize erosion and sedimentation.
- Slow surface runoff entering water bodies.
- Protect and enhance riparian functions wherever direct access to the river or lake is not required, emphasizing the creation of multiple vegetative strata, species diversity and the use of plants native to the region.
- Blend slope plantings with those installed in rear yard setbacks of River Non-Dependent areas.

Considerations:

- Banks and shorelines are considered "stable" if they are not actively eroding and are substantially covered by vegetation or structural materials.
- Slopes are defined as the area extending from the top of bank to a point 24 inches below the normal water line.
- Top of bank is defined as the point on the lake or river edge closest to the water where the angle of the slope becomes less than or equal to 10 percent.
- Consistent with the guidelines developed for the Chicago River, a minimum 30-foot setback is required in areas where river-dependent activities (such as loading and unloading materials from boats and barges) are not taking place.
- Examples of BMPs that may be placed within the 30-foot urban greenway include: bioretention, stormwater wetlands, vegetated filter strips and vegetated swales.
- Examples of BMPs that should be located outside of the 30 foot urban greenway include: permeable pavers, oil and grease separators and other non-vegetated, structural features.

Design Standards, River Dependent Use:

- Create fully protected land/water interface:
 - Leave no areas of erodible soils.
 - Prevent the direct drainage or discharge of stormwater to adjoining water bodies, by first routing such stormwater through a BMP.
- Drain impervious surfaces next to the water's edge or low permeability materials such as concrete, asphalt or gravel, away from the waterway (see Figure V-22 and V-23).

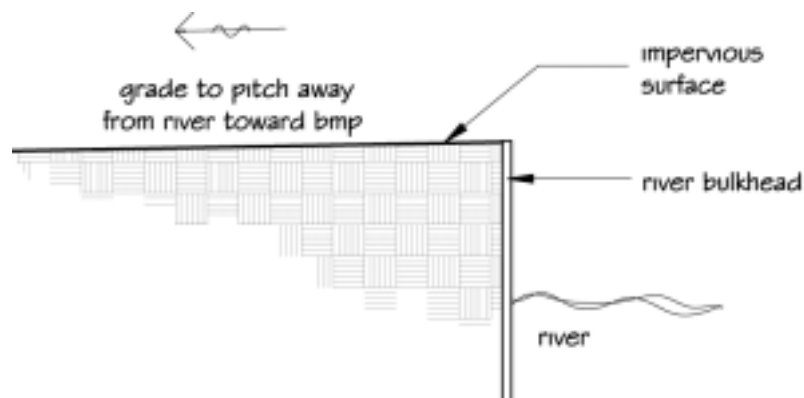

Figure V-22: Draining low-permeable materials, such as asphalt or concrete, away from river or lakes

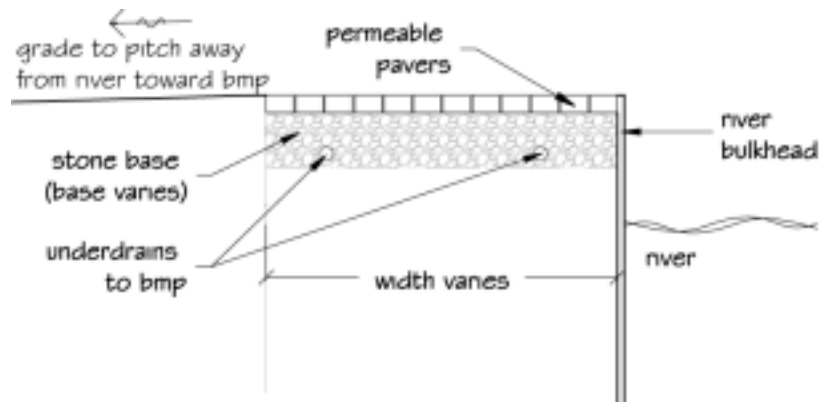

Figure V-23: Draining pavements and permeable pavers away from river or lake

- Collect runoff in a stormwater system that uses best management practices for pre-treatment, prior to discharge.

Design Standards, River Non-Dependent Use:

- Establish a minimum 30 -foot vegetated urban greenway that extends back from the top of slope or edge of the bulkhead:
 - Plant the first 30 feet of the urban greenway, extending away from the river or lake in riparian vegetation (see Figure V-24); and
 - Vegetate any additional buffer required beyond the minimum setback in either riparian or savanna communities.

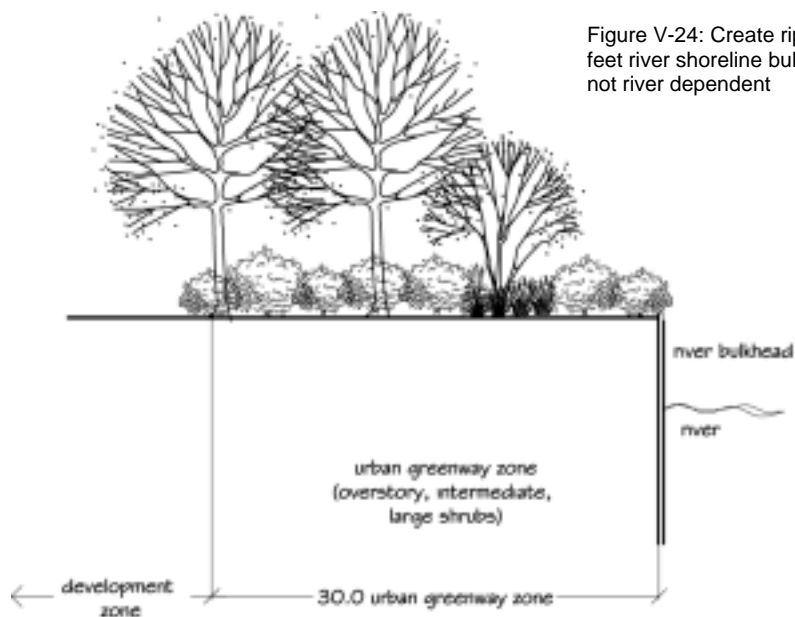

Figure V-24: Create riparian planting within first 30 feet river shoreline bulkhead when properties are not river dependent

- Leave stable slopes in place and establish a minimum 30-foot setback, as measured horizontally from edge of water. (See Figure V-25).
- Provide a minimum 30-foot greenway zone extending from the top of slope toward the interior of the development:

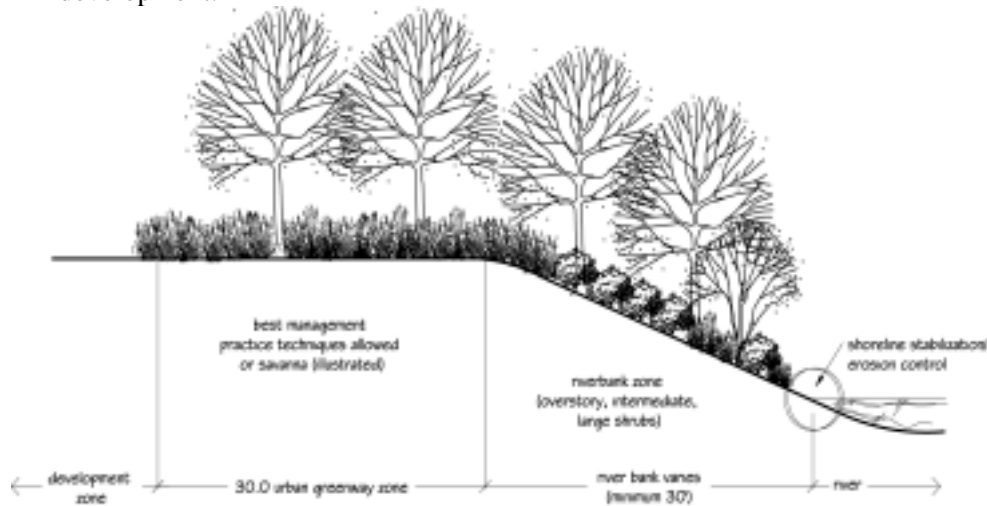

Figure V-25: Establish minimum 30-foot riparian zone next to edge of water when properties are not river dependent.

- Install vegetated stormwater BMPs in the 30-foot urban greenway, where desired, but not on the slopes
- Re-grade unstable slopes, and create a minimum 30-foot urban greenway zone (as measured horizontally from edge of water) on these modified slopes (see Figure V-26).
- Limit the use of filter strips in the 30-foot urban greenway to the upper 15 feet of the buffer, with the remainder of the filter strip extending into the development area.

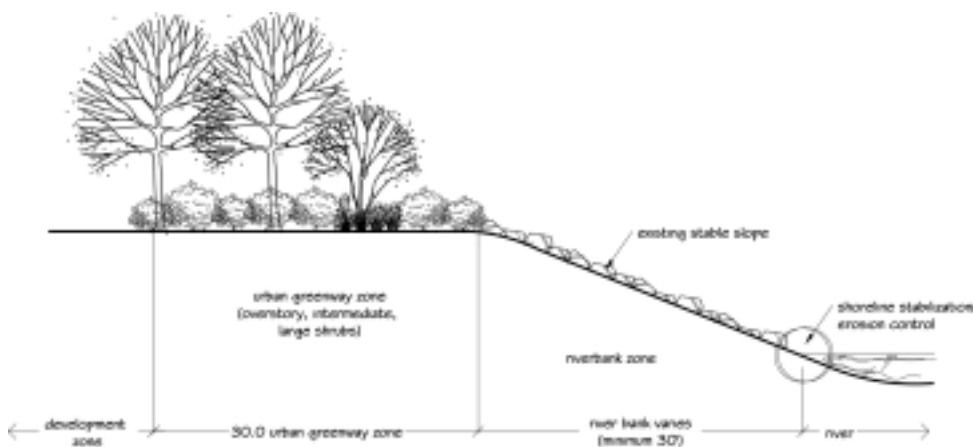

Figure V-26: Create riparian planting within the first 30 feet of a river shoreline when properties are river non-dependent

Planting Recommendations:

Components	Plant Community	Design Standards
Riparian Zone	Overstory Trees, Woody Plant List #1 or #4	1” caliper min, w/every 5 th tree 2.5” caliper min; 3 trees per 1000 s.f.
	Intermediate Trees, Woody Plant List #1 or #4 Deciduous Shrubs, Woody Plant List #1 or #4 Low-Profile Prairie, Mix #7	6’ ft. B&B; 2 trees per 1000 s.f. 30” height, 10 per 1000 s.f. Seed: 47.03 lbs. per acre
	<i>OR</i> Wet-Mesic Prairie, Mix #3	Plugs: 50 per acre in 2.5 containers @ 24” o.c. (avg.) Seed: 44.59 lbs. per acre Plugs: 80 per acre @, 24” o.c. (avg.)
Savanna	Overstory Trees, Woody Plant List #1 or #4	1” caliper min, with every 5 th tree 2.5” caliper min; 0.25 tree per 1000 s.f.
	Intermediate Trees, Woody Plant List #1 or #4 Deciduous Shrubs, Woody Plant List #1 or #4 Low Profile Prairie, Mix #4	6’ ft. B&B; 0.25 tree per 1000 s.f. 30” height, 7 per 1000 s.f. 47.67 lbs. seed/ac 50 plants/acre @ 24” o.c. (avg.)
	<i>OR</i> Mesic Prairie, Mix #2	56.03 lbs. seed/acre

Section V (j) – Transitional Landscapes

Transitions from one landscape type to another can often involve dramatic changes in height or create rigid and artificial edges, undesirable in a naturalized landscape. Distinctly different landscapes should be blended to create a visual flow that is pleasing in character. Examples of contrasting landscapes might include the juxtaposition of low-mow turf with mesic prairie, ornamental foundation plantings with native grasses or hardscape with low-profile prairie.

Design Objectives:

- Create a flowing and natural landscape with smooth transitions from one landscape type to another.

Design Standards:

- Avoid visual crowding that can occur if prairie is used next to driveways or parking lots by installing a five-foot wide strip of low-mow turf between the paved lot and adjacent prairie (see Figure V-27).

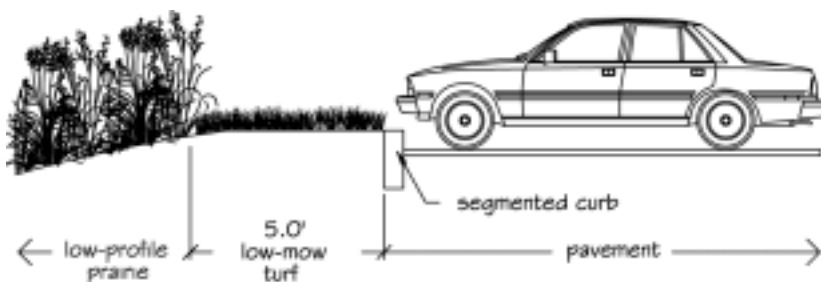

Figure V-27: Use five-foot strip of low-mow turf to create a transition from paved areas to taller prairie

- Avoid straight edges where distinctively different landscapes come together, by meandering the vegetative interface (see Figures V-28 and V-29).

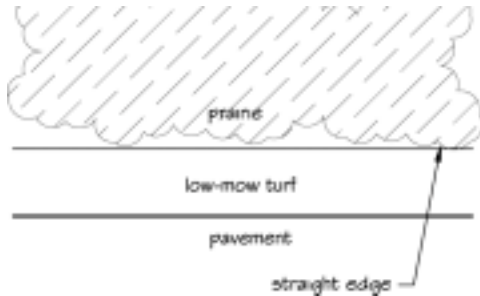

Figure V-28: Do not create a straight edge between naturalized prairie landscape and a different landscape planting, such as low-mow turf, interface

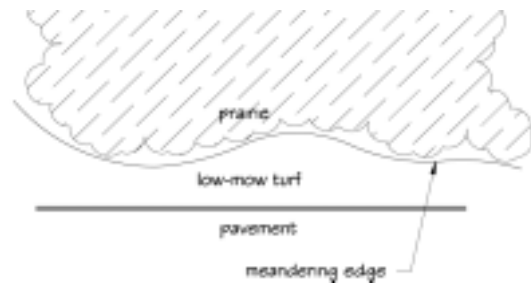

Figure V-29: Create a meandering edge between prairie and low-mow turf, consistent with the naturalized theme of the Calumet Area.

- Avoid linear and repetitive installations of trees and shrubs, where such vegetation is provided. Use native plantings that provide more random and gradual changes in height, texture and color.

Recommended Plantings:

Components

Groundcover
Trees and Shrubs

Plant Community

Low-Mow Turf
See general plant list, **Appendix B**

Design Standards

Seed: 5 lbs. per 1000 s.f.

Section V (k) — All Other Non-Developed Areas

The intent of these guidelines is to create a landscape within the Calumet Area that is consistent in character (i.e., naturalized with an emphasis on native plant communities) and environmentally functional from a wildlife, water quality and stormwater management perspective. As such, the use of short-mowed turf grasses and the establishment of manicured lawns specifically should be avoided, except within parkways along the perimeter of the Region, where an established landscape includes such grasses as well as curb and gutter. Landscapes for those areas not specifically called out in this document may be planted with any material selected from any single recommended plant list, with the exception of perennials and low-mow turf grasses

SECTION VI – SPECIFICATIONS

Section VI (a) – Trees and Shrubs

This section outlines basic provisions that should be incorporated into final planting plans and specifications for trees and shrubs. They are intended to provide guidance to the designer, but should not be considered a substitute for the preparation of detailed planting specifications prepared to fit the needs of the site.

Quality of Plant Materials:

- All trees and shrubs should meet the standards of “American Standard for Nursery Stock,” ANSI Z60.1-latest edition, American Association of Nurserymen, which by reference is made a part of these guidelines. References to minima and maxima with respect to plant height and spread, rootball diameter and depth, etc., are from this publication.
- Trees and shrubs should be high quality nursery-grown stock and should meet all requirements of federal, state, and local law with respect to plant type, labeling, nursery or plant inspection, disease, insect, and other pest infestation, and any other requirements. Substandard “B-grade” or “Park grade” plants are not acceptable.
- Field-collected plants are not acceptable, even if they have been subsequently planted in the ground in a nursery or planted in a container.
- All trees and shrubs should have been grown in a climate zone similar to Chicago’s, i.e., United States Department of Agriculture (most recent USDA zone hardiness map) zone 4 or 5 (zone 5 plants are generally hardy only near the warming influence of Lake Michigan). Plants from zone 6B or more, i.e., warmer climate zones, are not acceptable.

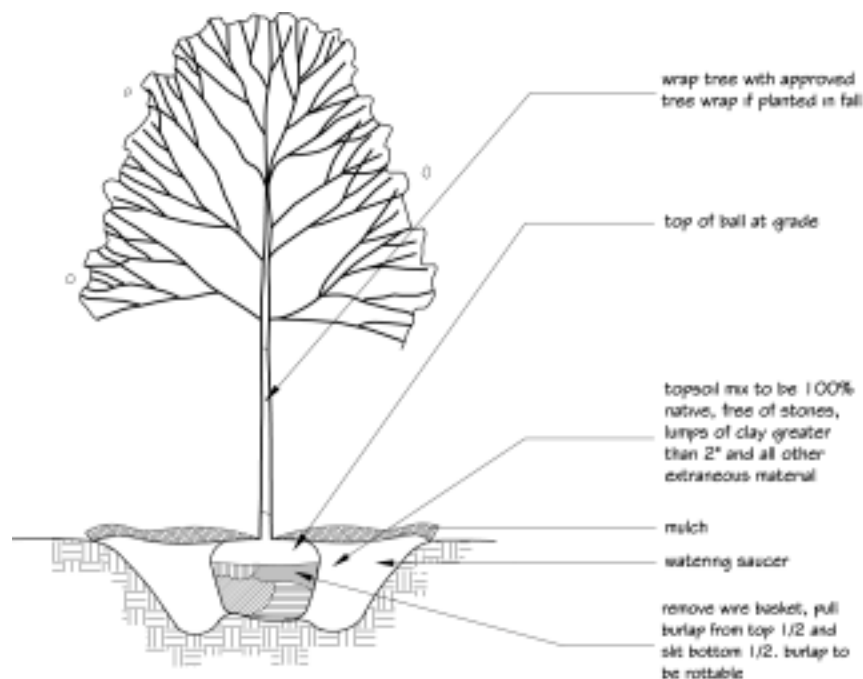
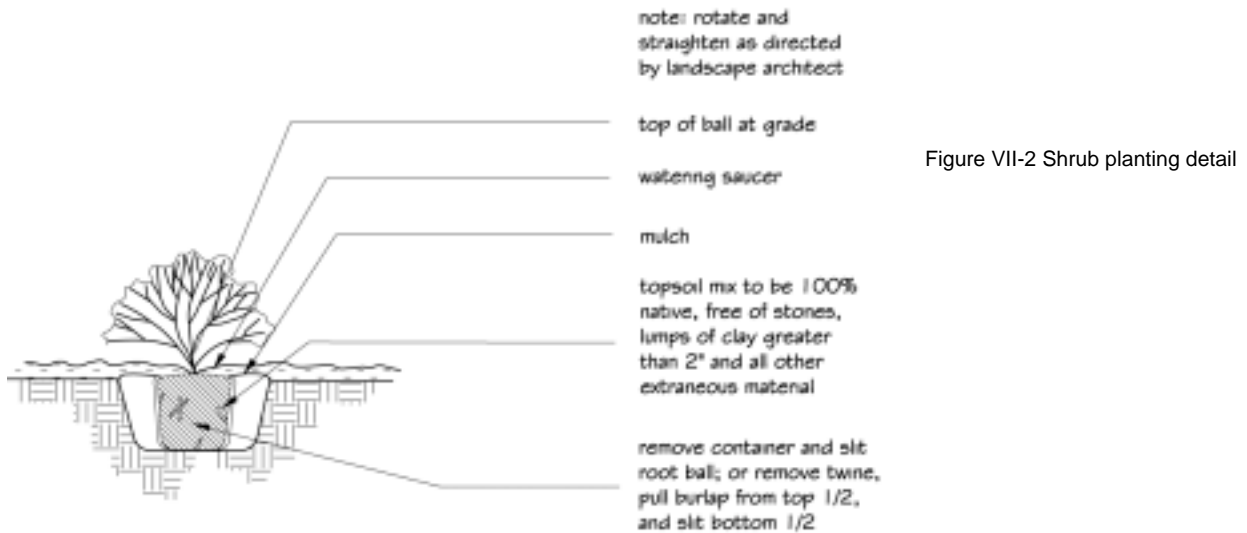

Figure VII:-1: Tree planting detail

- All trees and shrubs should be in a healthy, vigorous condition, free of dead or broken branches, scars that are not completely healed, frost cracks, disfiguring knots, broken or abraded bark, redundant leaders or branches, rubbing branches, or aberrations of any kind. Plants should not have multiple leaders, unless this is the natural form; multi-stem trees are not acceptable for required planting in parkways. In addition, they should have full, even, well-developed branching and a dense, fibrous, and vigorous root system.

Digging and Handling:

- Balled-and-burlapped (B&B) trees and shrubs should be dug with a firm rootball of natural earth, of a size in proportion to the plant’s size, as measured by caliper, height, or spread.
- Balled-and-burlapped trees and shrubs should be handled only by the rootball, not by the trunk or branches, as this may break or loosen the rootball and damage the root system.



- Containerized plants should have been established for a minimum of one full growing season in their containers before installation, and should be handled only by the container, not by the stems or branches, as this may pull the plant out of the container and break or loosen the rootball and damage the root system.
- Bare-root trees and shrubs are acceptable, if they are dug and installed at the appropriate season and handled in the appropriate manner.
- Plants should be protected from drying-out during shipping with tarpaulins or other covering.
- Plants should be protected from drying-out after delivery by planting immediately; if this is not possible, the rootball shall be covered with peatmoss or earth, and watered frequently to keep it moist until planting.
- Handling should not, move, bind, tie or otherwise treat plants so as to damage the rootball, roots, trunk, or branches in any way.

Unacceptable Forms:

The following tree forms are unacceptable for parkway planting:

Espalier or topiary: geometrical plant forms achieved through pruning which are contrary to natural form

Dwarf or small-scale: those trees which grow higher than 3'-0" but cannot be undertrimmed to a minimum height of 6'-0"

Topped or dehorned: trees with most of the crown removed, such that the main branches end abruptly in stubs

Section VI (b) – Groundcovers and Perennials**Groundcover/Perennial Planting Standards:**

The planting of groundcovers and perennials is encouraged as accents to parking islands and entrances to buildings. The planting of perennial varieties that are similar to native grasses will enhance the appearance of the natural landscape in higher visibility areas.

Groundcover and Perennials should be selected from Appendix A.

General Guidelines for Groundcover and Perennial Plantings:

- The planting beds should be loosened when the soil is moist prior to planting by tilling. Planting beds should be tilled to a depth of six inches.
- Organic matter such as mushroom compost should be spread over the bed to a depth of two inches after the soil has been loosened. The organic matter should then be worked into the bed by tilling.
- Fertilizer should be top-dressed over the bed area (except when compost is applied) based on soil test results. In the establishment stage, liquid fertilizer may be applied to annuals as directed by owner or landscape architect.
- Mulch should be applied to a minimum depth of one inch and a maximum depth of two inches.
- Groundcover and perennial plants should be maintained below three feet in height when adjacent to traffic areas in order not to obstruct visibility.

Planting Groundcover and Perennials:

- Plants, either potted or bare root, shall be installed so that the roots are surrounded by soil below the mulch. Potted plants should be set so that the top of the pot is even with the existing grade. The roots of bare root plants should be covered to the crown.

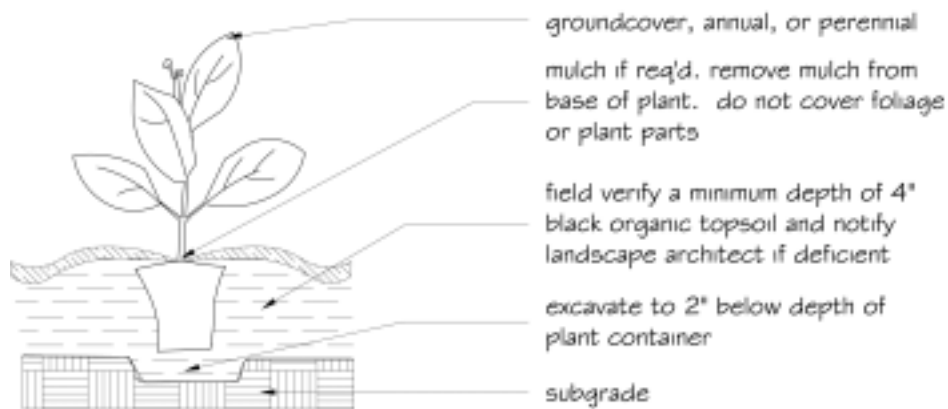

Figure VII-3: Groundcover, annual and perennial planting detail

- Spacing of plants to be installed should achieve coverage within two years.
- The planting bed should be mulched and treated with pre-emergent, soil-applied herbicide if directed by the landscape architect. Pre-emergent herbicide should only be applied when the foliage is dry to prevent foliar burn.

Section VI (c) – Native Prairie

The long-term success of native plantings largely depends on the environmental sensitivity of the construction process and the accuracy of its earth-disturbing activities. Because of the wide range of potential conditions, a recipe for native area installation cannot be given. Information presented in this section should be considered a guideline, rather than an absolute. The designer will need to take into consideration a variety of factors when creating prairie, such as: soil composition and depth; moisture regimen; access to sunlight, design, and desired function (i.e., water quality enhancement, etc.).

Design Guidelines for Prairies:

Planning a natural landscape typically includes a site inventory, site analysis, and design by a qualified professional (e.g., an ecologist for wetland, prairie, riparian, and woodland systems) followed by development of a plan (including installation, management, and monitoring):

- Include both a landscape architect and ecologist on the design team, since the majority of the new landscape in the Calumet Area will be comprised of natural communities.
- Involve these professionals early in the process, including the pre-design/programming phase and the development of a schematic design. Site visits, to facilitate accurate determination of the proposed design's adaptability to the site, are critical for designing a successful landscape and BMPs.
- Identify disposal methods for all existing vegetation on project plans.
- Plan for fire safety with prescribed burning as part of the *site landscape design*. It is recommended that a *minimum* 20-foot firebreak be established between prairie and buildings as part of the preparation for a prescribed burn.

Establishing Prairie Grasses and Flowering Plants:

- An uncontested requisite of a prairie community is a large amount of sunlight (ideally 75 to 100 percent sunlight).
- A variety of methods can be used; however, care must be taken to ensure the site is well prepared, weed free, and that seed is placed properly.
- Prairie grasses are not seeded the same as turf grasses.

Plant Mixes:

Appendix A lists seed mixes developed for use under various conditions. If not installed concurrently with the temporary matrix, the desired long-term vegetation should be installed at the next appropriate window. Seed should be applied according to the specified rates on the plant list(s).

Native Grass and Wildflower Mixes – Seed mixes deliberately have a large number of different grasses and wildflowers because diverse plantings are more resistant to flooding, drought, and pathogens than monotypic or low-diversity plantings. In transition areas by parking areas or buildings, the designer may opt to include more showy, non-native wildflowers (e.g., "Prairie in a Can"); however the designer should adjust the selection of plants to exclude aggressive non-natives such as Dame's rocket, etc. Seed should be clean and weed-free.

Origin Requirements – Local ecotypes should be preserved. Therefore, all seed and plant stock is to be obtained from sources within a 150-mile radius of the Calumet Area.

Seed Treatments/Inoculants – Seeds of many native species require specialized treatments such as cold/moist stratification, scarification, etc. Where mycorrhizal inoculants are needed, prairie seeds should be properly treated with endo-mycorrhizae (specifically VA mycorrhizae), not ecto-mycorrhizae, which are for woody plants. Many native species go through seed treatments naturally if installed in the fall. Seed used in spring application should have mycorrhizal treatment/pre-stratification as appropriate.

Cover Crop – A temporary cover crop should be installed to protect the ground surface in areas not scheduled for planting to the permanent seed within 15 days after earthwork and seedbed preparation have been completed. Cover crops primarily should consist of annual species that have limited allelopathic tendencies (e.g., seed oats). Species such as winter wheat, perennial fescue appear to have greater allelopathy and should not be used. Annual rye should never be planted at more than 5 pounds per acre. Perennial rye should not be used. Cover crop should not be planted at traditional seed rates (e.g., 70+ lbs/ac) unless it is being seeded alone and will be providing site stabilization.

Preliminary Site Preparation:

Soil preparation is critical to the success of a native planting. For best success, a full year should be devoted to eliminating weedy species prior to seeding natives. Proper weed control and soil preparation are the two most important steps in the installation process.

Topsoil (i.e., the upper 12 inches of soil, where not contaminated with historic fill materials) should be handled separately from subsoil materials. Where available, at least 12 inches of topsoil should be provided to achieve final grade. If not suitable for reuse, earthen material must be disposed of at an

appropriate off-site location. Topsoil should not be too fertile, which can encourage the growth of invasive plants.

Competing vegetation should be removed using one or more of the following methods:

- Prescribed burning
- Chemical treatment (use low toxicity)
- Tillage
- Mowing
- Removal by hand

If chemicals are used, a non-persistent herbicide such as glyphosate (e.g., Round-up™) should be applied per manufacturer's specifications. Up to three treatments may be needed for full control. Seeding should occur approximately seven days after the final treatment.

Soils that become compacted will need to be ripped prior to planting. If compaction is not a concern but the seedbed needs to be loosened to a depth of three inches prior to seeding to ensure good seed-soil contact, disking or raking should be performed. A properly prepared seedbed will be smooth and free of soil clumps, much like that of a properly prepared lawn.

Seed Installation:

The following are general “rules of thumb” when seeding prairie plants:

- Prairie seeds prefer a firm seed bed
- Large and/or fluffy seeds should be buried 0.25-inch deep
- Small and/or fine seeds (most forbs) should be scattered over the soil surface
- Seeds should be lightly covered with soil, harrowing or raking works well.
- In general, fertilizers should not be applied for native seedings except as indicated in other sections of this manual. They will encourage weeds.

Seeding rates are specified in each seed mix and reflect rates for drill seed installation. If broadcast seeding is performed, the indicated seeding rates should be doubled. Seed mixes should be installed using a drill seeder that accurately meters the types of seeds to be planted and keeps all seeds uniformly mixed during the drilling (e.g., a Truax-type seeder equipped with separate boxes for large/fluffy seeds and small/fine seeds and disc furrow openers and packer assembly). The maximum row spacing should be eight inches. Large/fluffy seeds should be placed to obtain a final planting depth of 0.25 inches. Small seeds should be drop-seeded onto the soil surface. All drill seeding should be done at a perpendicular angle to the flow of surface drainage.

Broadcast seed methods should be used for areas that are not suitable for installation by drill seeding. Typically, the native landscape contractor performing the installation will determine the optimal method for seed installation in each area. The last areas to be reseeded should be the equipment access points. The site should be lightly harrowed or raked following seeding. Mulch should be applied and disc-anchored following packing.

A typical schedule for seeding is as follows:

- Spring Seeding (spring seeding, favors grasses)
 - Prepare site (late April-May).
 - Seed (1 May-1 July, preferably before 15 June as late plantings risk hot weather that may affect success of the planting).
- Fall Seeding (fall seeding, favors wildflowers and can be successful especially with dry soils)
 - Prepare site (late August through September); and
 - Seed (15 October to soil freeze-up).

Erosion and Sediment Control:

New seedlings should be protected by covering it with mulch or erosion blanket. This is especially important for seedling survival on clayey soils.

Slopes that are 3:1 or gentler can be mulched with a certified weed-free grain straw or native grass mulch per acre and disc anchored following seeding. Mulching should be performed using 2 tons of straw mulch. The soil surface should not be buried (i.e., less than 1 inch straw depth), but some soil should show through the mulch (i.e., achieve 90 percent coverage of the exposed soil surface). Mulches derived from pasture hay containing reed canarygrass, smooth brome, or other introduced forage species (e.g., alfalfa, sweat clover, vetch etc.) may contain enough seed to ruin the native grass and forb planting. They should not be used for native seedlings. Mulch should be in an air-dried condition at the time of application.

Slopes steeper than 3:1 should have seedlings covered with erosion control blanket. Generally, straw blanket containing double netting performs satisfactorily. If seeding is done in swale that will receive moderate flows of water for periods of time, a jute or coconut fiber blanket should be used. Other more severe conditions such as very steep slopes or channels exposed to high water velocities will require more rigorous treatments.

Plug Installation:

Containerized plant materials should be in a minimum of 2.5-inch containerized pots (open bottoms preferred) unless larger materials are specified. Materials should be installed by hand such that the potting soil is covered with approximately 0.25 inch of crumb native soil. Plugs should be planted in sunlight and moisture conditions appropriate to each species. Care should be taken to achieve a reasonably random distribution of plant materials (i.e., not planted on formal grid structure). Materials should be planted in clusters of approximately 7 individuals per species, located on a maximum spacing of 3-foot on-center.

Section VI (d) – Wetlands

Plant Materials:

For all operations that occur when the soil is not frozen, equipment shall have low-pressure tires to minimize compaction. Depending on water levels at the time of installation, seed may be used in place of or to supplement tuber and plug materials. If seed is used, the designer should reference the specifications for prairie presented in Section VI (c).

Local ecotypes should be preserved. Therefore, all plants and plant propagules are to be obtained from sources within a 150-mile radius of the Calumet Area and be species and subspecies native to the Chicago Region.

Containerized plant materials should be in a minimum of 2.5-inch containerized pots (open bottoms preferred) unless larger materials are specified. Each should have a well-established root system. If installed in standing water, containerized plugs should have a minimum of 10 inches of growth and should remain uncut. All plant material, including collected stock, needs to comply with the State and Federal laws with respect to inspection for plant diseases and insect infestations.

Plug/Tuber Installation:

Wetland plugs should be hand installed between 1 May and 15 June. Plugs should be placed in locations where springtime moisture conditions are appropriate to each species. Care should be taken to achieve a reasonably random distribution of plant materials in natural areas. Plant materials should be installed in multiples of 5, 7, or 15 of a species and be placed on 1- to 3-foot centers as based on an individual species' growth rate.

Tubers or rhizomes that do not require weights for submersion should be installed in the bottom soil at a depth not to exceed two times the propagule's largest dimension (typically planted under one inch of soil or mud). Only containerized plugs with at least 10 inches of vegetative growth should be installed where water is greater than four inches deep. Herbaceous plugs and plant propagules lacking herbaceous matter should be installed in areas with less than two inches of water, such that the potting soil is covered with approximately 0.25 inch of crumb native soil. Plugs should be pushed into the soil so that the root or tuber is entirely buried and so they are 0.5 inch lower than they were grown in the nursery to provide soil cover over the root system. Planting should be performed as soon as possible after digging the planting holes so that the excavated soil does not dry out.

Emergent plugs should be installed within protective enclosures configured as appropriate to the planting area. Herbivory protection also may be appropriate in wet prairie and wet-mesic prairie areas lacking standing water.

Section VI (e) – Stormwater Wetlands

Planting specifications for stormwater wetlands will follow closely those recommended for prairie (upland slopes) and those prescribed for wetlands (shoreline and below). The reader is referred to Sections VI (c) and (d) respectively. A significant distinguishing feature of a stormwater wetland is the need to accommodate a regularly fluctuating hydrological regimen. Stormwater wetland basins should be sized accordingly to allow water levels to rise and return to normal levels within 24 hours under the the 10-year frequency, 24-hour storm event.

Plant mixes should contain a large percent of salt-tolerant native species adapted to irregular water levels associated with urban storm runoff, as well as plants adapted to nutrient loading. Plugs should be used when standing water is present, with a minimum of 4,000 plugs per acre. However, plugs within the bottom of the basin and along the water line should be installed on an average of 18 inches on center.

When wet-mesic prairie is used in stormwater wetlands, species should be specifically selected for their adaptability to a wide range of growing conditions, where plants will do best in damp to saturated soils but will tolerate periodic dry stretches. Plant selection should focus on shoreline stabilization.

Section VI (f) – Woodlands

Establishing Woodland Understory Plants:

- In an area that is not currently wooded, the initial groundcover will need to be tolerant of sunny conditions. As the canopy matures, the sun-loving groundcover will decrease and seed/plants tolerant of shade and partial shade should be installed.
- Approaches in enhancing and restoring existing woodland areas differ from creating woodlands.
- The design should include both faster-growing species and longer-lived, slower growing woody plants. Use of variable caliper sizes is appropriate to promote uneven-aged stands.

Plant Mixes:

Appendix A includes seed mixes developed for use under various moisture and shade conditions. If not installed concurrently with the temporary matrix, the desired long-term vegetation should be installed at the next appropriate planting opportunity. Seed is to be applied according to the specified rates on the plant list(s). Seed specifications are presented under Prairie.

Woody Plants:

See specifications in Section VII (a). Within a created riparian or woodland community on a property, there should be at least five different species of trees and five different species of shrubs to provide diversity.

Preliminary Site Preparation:

For enhancement of an existing woodland system, the primary focus should be on weed control and removal of excess canopy, possibly including selected natives if determined appropriate by an ecologist. Methods for removing competing vegetation were discussed under Section V(c) Prairie. For enhancement of existing woodlands, soil disturbance should be minimized. Sufficient shade should be left to provide good conditions for development of woodland grasses and flowers. If it does not create a fire hazard or weed problem, some of the felled vegetation should remain in place and allowed to rot, as this will improve the soil condition. Occasional standing dead trees should be provided, as they afford valuable habitat for many wildlife species. Soil should be protected from compaction, as oaks are particularly sensitive to this. Typically further soil preparation is not needed in existing woodlands prior to seeding.

For creation of woodland areas, follow specifications as outlined for installation of woody plant materials and for prairie understory. In these situations, woody plants should be clustered and placed within mulched beds so that the young trees are not overwhelmed by the prairie as they mature. You may wish to allow your prairie groundcover to establish before installing woody plantings.

Seed Installation:

In existing woodland situations, seed should be broadcast applied as discussed under Prairie except that harrowing or raking is unnecessary; rain will splash loose soil over the seeds. For created woodlands, the prairie installation prescriptions should be followed.

Section VI (g) – Soil Specifications

Soil failures are often the reason for poor landscape performance. The following information is provided to assist the designer in developing adequate specifications for soil procurement, installation and grading. This specification is not inclusive but is indicative of the soil properties that are necessary for the growth of redevelopment of the Calumet Area.

Quality Assurance:

All materials and work should comply with applicable codes, standards and with the requirements of local agencies. The Contractor should be responsible for obtaining all required permits. The Contractor also should engage a Certified Professional Soil Scientist or Certified Professional Soil Classifier to identify acceptable soil materials for import to the site. The cost of this evaluation is born by the Contractor.

The Contractor should engage a laboratory certified by the Council of Soil Testing and Plant Analysis Laboratories for imported soil. The cost of this testing is born by the Contractor. All soil sampling and testing must comply with procedures specified in Methods of Soil Analysis Parts I and II, most recent edition, American Society of Agronomy, Madison, WI except where ASTM methods are specified.

Soil Data:

Documentation should be provided to the Landscape Architect verifying that soil mixes have been obtained from approved source(s), and noting the approximate quantities obtained at (each) source.

The Contractor should provide soil tests of soils imported to the site prior to delivery of any soil to the site along with a soil analysis report containing soil tests and lab analyses stating whether soil meets specification requirements. Chemical analysis should include: pH, pH in 0.1M CaCl₂, Cation Exchange Capacity (CEC) by the Ammonium Acetate Method, Percentage of Organic Matter (OM) by Weight, Available Phosphorus (P), Exchangeable Potassium (K), Exchangeable Calcium (Ca), Exchangeable Sodium (Na), Exchangeable Mg, Percent Base Saturation Soluble Salts by saturation extract, Estimated Nitrogen Release, and Sodium Adsorption Ratio. Particle size distribution and soil texture should include percentages of sand, silt and clay, USDA Textural Class Designation and sand fractionation by ASTM D422-63.

Product Harvest, Delivery, Storage and Handling:

The harvest of soil should be coordinated with the Landscape Architect and Soil Scientist. Soil should be harvested directly from its natural state by backhoe loading to trucks. All soil should be moved in its in a fresh state without shredding or grinding. Scrapers or pans should not be used to harvest soil. Soil should not be harvested, transported, or placed wet, nor should it be harvested and stored in a stockpile for later movement to the site.

Soil should be harvested in such a manner as to not destroy the natural soil structure. Soil containing woody roots may be screened provided that the structure is not destroyed. Soil should not be pulverized, stockpiled or amended without the permission of the soil scientist. All deliveries of soil, which in any way fail to meet specifications should be rejected. No deliveries should be permitted when weather conditions are unsatisfactory, or if the approved staging area is not in a satisfactory condition to receive soil. No frozen soil should be accepted. Do not deliver or handle soil in wet, muddy or frozen conditions. Water content should not exceed twenty percent (20%) by weight. Temporary on-site stockpiles should be protected from water erosion, wind and disturbance with landscape fabric, tarps or other materials approved by the Landscape Architect.

Site Conditions:

Prior to beginning work, and regularly for the duration of landscape operations, the contractor should examine and verify the conditions and readiness of the job site and notify the general contractor of unsatisfactory conditions. The contractor should not proceed with the work until unsatisfactory conditions have been corrected or resolved.

Soil Materials:

Landscape Soil:

A naturally occurring or modified mix of loam or silt loam (USDA texture) soil should be approved by field inspection at the harvest or production site by the Certified Professional Soil Scientist or Classifier. Soil should not be mixed, transported, or graded if moisture content exceeds 75 percent of field capacity or if any part of the soil is frozen.

Natural soil should be a harvested loam or silt loam mineral soil, uniform in color and texture, containing no gray clay and free from grass roots, sod, weeds, rocks, stiff clay, clods, or any other substance undesirable to plant growth. The soil should be loose, friable, and of good tilth. The particle size distribution ranges using USDA Particle Size Classes should be as follows:

Sand	2.00 – 0.05mm	15-50%
Silt	0.05 – 0.002 mm	30-70%
Clay	<0.002mm	3-20%

Soil Chemical and Nutrient Data:

Acceptable soil chemical and nutrient data is as follows. All soil sampling and testing should comply with procedures in Methods of Soil Analysis Parts I and II, most recent edition, American Society of Agronomy, Madison, WI.

Constituent	Range
pH	5.5-7.0
Organic Matter	3 –10% (dry weight)
Phosphorus (Strong Bray)	20 - 40 ppm
Potassium	200 - 600 ppm
Calcium	1,500 - 4,000 ppm
Sodium	< 250 ppm
Cation Exchange Capacity	20 -100 cmol/kg
Soluble Salts	≤ 1.5dS/m
SAR	< 5

A minimum of one soil sample with the accompanying soil test report should be provided per 500 cubic yards of material. Samples should be obtained randomly throughout the source field location or stockpile.

Naturally occurring soil may be amended at the direction of the Landscape Architect or Soil Scientist to meet the physical, nutrient, or chemical specifications.

Soil Conditions and Preparation:

Planting soil should have a dry density in-situ not to exceed 100 lbs. per cubic foot. The Coefficient of Uniformity should be 2.50 or greater, and the soil should meet organic matter characteristics described below

in organic matter amended soil. The planting soil should be uniform in color and texture, containing no gray clay and free from grass roots, sod, weeds, rocks, stiff clay, clods, or any other contaminants. Soil pH range must be between 5.5 and 7.0. Soil can be amended with acidifiers approved by the Landscape Architect to meet this requirement, as appropriate. Soil should not be mixed or worked while wet.

Organic Matter Amended Soil:

Amended soil should use landscape soil as described in the Landscape Soil section above as the base material for the soil mix. It should be amended with composted organic material meeting the requirements of Organic Matter Amendment Requirements below. Amended Soil should:

- Consist of 2.5 parts landscape soil to 1 part composted organic material.
- Be mechanically blended off-site.
- Be mixed and stored in a dry condition until placement. Amended soil should not be stored in stockpiles nor stored for more than 14 days.
- Be submitted to the Landscape Architect for approval prior to placement. All testing requirements for landscape soil shall apply to amended soil.

Organic Matter Amendment Requirements:

All compost materials should be stable, mature humus-like materials produced from aerobic decomposition of biosolids from one or more of following sources: yard waste, agricultural residuals, hardwood and coniferous debarking waste, brewing solids waste; source separated municipal waste and/or paper pulping waste.

Compost should not contain any toxic materials including PCBs or Dioxin and must meet EPA Type I organic waste material requirements. Compost must not exceed any §503 human contact standard maximums and must be certified to comply with all SW-846 sampling and testing protocols. Compost maturity must demonstrated for every 250 cubic yards by meeting the Solveta requirements for compost maturity by having a test value greater than or equal to 7. The compost should be dark brown to black in color, and capable of supporting plant growth, with appropriate fertilizer amendments. Compost should have the following chemical characteristics:

Constituent	Range
pH	5.5-6.5
Soluble Salts	< 2.0 dS/m
C:N	10:1 to 33:1
OM	≥ 50%

Finish Grading:

Sub Grade Preparation – The sub-base should be free of gravel and stone other than those that are part of the natural matrix. The sub-base should be coarse graded to create positive drainage prior to scarification and re-compaction. The coarse-graded sub-base then should be thoroughly tilled to a minimum depth of 12 inches. This material should then be re-compacted to a minimum of 78 % of Proctor Density and a maximum of 84% of Proctor Density. Following re-densification, the sub-base surface should be roughened to a minimum depth of 2 inches prior to placement of soil.

Placing Soil – The contractor should uniformly distribute soil throughout areas to receive turf, trees, and shrubs in quantity sufficient to provide a rough grade. Soil depth should be a minimum of 18 inches, but not exceed 36 inches without the approval of the Landscape Architect. Soil should be placed in 6-inch lifts and consolidated by trafficking with a low ground pressure tracked finishing bulldozer. Rubber tracked skid steers may be utilized for placement and consolidation of soil. Wheeled vehicles or skid steers without rubber tracks shall not place soil. Back dragging soil should not be permitted.

Section VII Management And Maintenance

Section VII (a) — Trees and Shrubs

Naturalized plantings of trees and shrubs require less intensive maintenance. After establishment of new plantings, the following general maintenance operations should be incorporated into the overall facility maintenance program.

Watering – After the establishment period has concluded supplemental watering during the first growing season is recommended. This will be especially important during hot dry periods of the year. Watering weekly for the first growing season when a one-inch rain is not received is recommended.

Pruning/Trimming – Woody plants will require a yearly program to remove dead wood and excess growth to maintain a open healthy canopy. This program should be performed primarily in the late fall and winter. Supplemental spot pruning/trimming may need to be done to remove dead branches that may present a safety concern. Pruning/trimming should be done to maintain the natural character of the plant.

Supplemental Planting – In order to maintain the character of the landscape periodic planting of additional trees and shrubs will need to be done. Budgeting of annual supplemental planting for the first five years should be anticipated. Once the canopy's of the trees grow and provide a more dense cover additional shade tolerant species of shrubs and groundcover may need to be planted.

Section VII (b) – Low-Mow Turf

Establishment – Low mow turf should be seeded between late August and late September for best results. March through mid May is also a good planting timeframe, however may require additional establishment activities since most weeds also germinate at this time.

Watering – New seed installations should be watered daily for the first six weeks. Water application rates should consist of fifteen to thirty minutes unless the soil is damp and watering rates should be adjusted. After the first six weeks watering may be cut back to every two to five days until establishment based on weather conditions.

Fertilizer & Weed Control – Fertilizer is not recommended and weed control should be applied on an as needed basis only for specific problems.

Mowing – Mowing operations should never remove more than one third of the top growth. Mowing is generally required once per growing season for general clean-up.

Integrated Pest Management (IPM) – The use of chemical applications should be considered as the last resort for spot treatment of infestation. Biological and non-toxic chemicals should be the first choice in pest management. Careful and regular monitoring of the landscape will assist in the early detection of problems.

Section VII (c) – Natural Areas

Natural landscape maintenance is different from traditional landscape maintenance. Natural landscape can reduce maintenance costs associated with traditional landscaping; however, just like any other plantings natural landscapes require management and maintenance. Long-term, the maintenance requirements of natural communities are generally much less than those of more ornamental landscaping.

During the first few years, more weeds will be evident than prairie plants and more intensive maintenance will be required. Maintenance efforts will likely decrease beginning around Year Three following installation. To promote successful establishment, the services of a qualified native restoration professional will be invaluable as the installed native community evolves. With respect to management, the initial priority should be to establish a matrix of grasses; supplemental wildflowers can be added later if desired.

The type of maintenance required depends on the system. A typical outline of management following native seed installation is presented below. As with installation guidelines, no “recipe” can be provided for natural area management and maintenance. However, the basic rule of thumb is that weeds must be controlled or the native community will not establish. Once established, native plants can out-compete most weeds that remain.

An EPA publication (<http://www.epa.gov/glnpo/greenacres/toolkit>) provides valuable information on selecting assistance for your natural landscaping project; sources of information and assistance; sources of native seeds, plants, and garden catalogs; and a selected biography.

Typical Maintenance Requirements:

Year 1

- 1) Mow (4-6 inches, late April-mid May) (following a fall seeding only).
- 2) Mow (8-10 inches), when cover crop and weeds are 1 to 2 feet high, usually once in mid- to late June and again between 15 July and 15 August (depending on how weather affects plant growth).
- 3) Mow – September (optional).
- 4) Weed control (mowing should keep down annual weeds; spot wick thistles, etc., spray application may be more efficient for larger areas but must be done in a manner that does not adversely affect desirable plants).
- 5) Watering (may be necessary during first two months of spring or summer planting when seed has germinated or plugs have been installed but are in early growth and a drought or heat wave begins).

Weeds should not be allowed to grow higher than 12 to 14 inches (even if this means sacrificing some of the short-term wildflowers), or they will deprive the prairie of light and water. A qualified, native landscape maintenance company should be contracted to perform weed control, as it is critical that the maintenance company have experience in recognizing prairie plants from weeds. A flail (preferred) or rotary mower should be used rather than a sickle-type mower, which leaves “hay” that will smother prairie plant seedlings. Cover crop should develop within two weeks of planting (except in dormant seedings). Seedlings should be spaced 1-6 inches apart in drill rows. Native grass seedings may be only 4 to 6 inches tall. Most prairie plants are warm season plants and do not begin growth until warm weather arrives. If there is a flush of growth from foxtail, etc., mowing should occur more often. Cuttings should not be left if they will smother the small prairie seedlings. Watering should only be performed during the morning, never at night. Once prairie plants develop their root systems, they will not need watering. In fact, excessive water can produce unappealingly tall, lanky plants.

Year 2:

1. Conduct a spring prescribed burn if sufficient fuel exists. If not, mow (3-4 inches in late March or early April).
2. Mow 4-6 inches in late April-mid May, if needed).
3. Mow (6-10 inches), June 15-August 15 if weeds are thick.
4. Mow – September (optional).
5. Weed control (mowing should keep down annual weeds; spot wick thistles, etc.).
6. Some sites may not require much maintenance the second year.

The cover crop will be gone. Grasses should form clumps 1 to 6 inches apart in drill rows but still short. Some flowers should bloom (e.g., black-eyed Susan, sand coreopsis, bergamot, etc.). If there is a flush of foxtail growth, mow the site.

Years 3-5

1. Mow only if and where necessary (spot treatments).
2. Weed control (spot treatment of thistles, etc.).
3. Conduct prescribed burn in spring or fall.
4. Maintenance efforts should begin to decrease.

At this stage, planting should begin to look like a prairie (i.e., tall grasses, flowers, etc.). During this “establishment phase” the prairie should be burned annually for five to six years. Burning should be performed by qualified personnel incorporating all appropriate safety precautions. Unless the site manager is trained in managing controlled burns by the U.S.D.A. Forest Service or other qualified agency, the site manager should contract with a qualified native landscape maintenance company. A prescribed burn permit must be obtained from the Illinois Environmental Protection Agency, and permits will likely be required from the fire and police departments.

Most existing woodlands are best initially managed by regular burning, understory re-seeding (as needed), and weed control. Created woodland areas will need reseeded and/or supplying woodland plugs approximately 10 or so years down the road because shading will make prairie elements disappear/decrease.

Long-Term Maintenance

1. Mow prairies only occasionally (spot treatments may be necessary).
2. Weed control (spot treatment of thistles, woody invasives, etc.).
3. For prairies, conduct prescribed burn in spring or fall (annual burn preferred, but at minimum every three years, alternating spring and fall burns); early fall haying may substitute for burning on occasion. Burning a prairie two years in a row will “clean up” rough-looking sites.
4. Wetlands may be burned in spring or fall. A fall burn may be more successful as water levels are typically lower.

5. Mature woodlands should be burned only in the fall, with the leaves used for fuel. Immature or created woodland and riparian areas should be managed as prairies until the canopy develops and the plant community shifts.

Once a prairie is well established (typically after five years), maintenance involves occasional mowing or controlled burning to maintain native plant diversity and control weeds. Certain noxious weeds may need focused control such as selective use of an appropriate herbicide. Fertilization is not needed for areas with native plantings, and should not be performed except as directed by an ecologist. Burning should be “prescriptive” (i.e., conducted to achieve specific goals such as targeting particular weed species, encouraging development of grasses or wildflowers, etc.). Prairie plants are generally free of pests and diseases, so insect control is not appropriate and may harm desirable insects.

Mechanical Control – Mechanical control of nuisance plant species typically includes mowing and/or the digging up individual plants by hand. In many cases, mowing a plant before its seeds mature will minimize further spread. Mowing at or very close to the ground surface with a weed-eater or hand-scythe can be an effective means of control for species such as sweet clovers, various thistles, and ragweeds. For general mowing of swaths of vegetation, mowers should be set to a height of 12+ inches above the ground surface or to a height that treats weedy species yet minimizes impacts on desirable plants.

For species such as common reed, purple loosestrife, Canada thistle, and reed canarygrass, mowing actually encourages the spread of underground stems. Hand pulling or digging out these species and woody undesirables such as multiflora rose can be used as an effective means of control if there are fewer than 100 plants throughout the entire site. Where more than 100 individuals of such plants are present, chemical control should be the primary method of control.

Chemical Control – Because of the potential for damage to native plant communities, the use of preventative herbicides should be limited to problem areas and problem species where manual measures are ineffective. Manual weed removal and prescribed burning are preferred means of vegetation management. Aquatic herbicides should not be used to treat algal blooms.

Employed in conjunction with prescribed burning and mechanical control, the judicious use of herbicides can be an important component of management programs for controlling invasive species. Some species, such as purple loosestrife, buckthorn (*Rhamnus* spp.) and honeysuckle (*Lonicera* spp.), reed canarygrass, common reed, sandbar willow, and cattails are controlled more effectively by chemical treatment than by mechanical control measures.

Glyphosate herbicide (trade names Rodeo or Roundup) is often recommended for use in native areas. Other herbicides such as Transline, Plateau, and Garlon also have been used in natural areas. The application of herbicides should be performed only by a licensed professional applicator according to approved rates and procedures. Herbicide application should be conducted in strict compliance with all warning labels and applicable codes, standards and best management practices.

Generally, wick application is more selective than spray application. Wicking applies herbicide only to individual plants, using a canvas-covered, perforated, chemical filled PVC pipe. Trained personnel walk the area, swinging the eight-foot pipe from side to side above the native plants but deliberately striking invasive species. The pipe strikes and bends the weeds, smearing them with the chemical and destroying them within a few days. Spray applications, if used, should not be conducted on windy days because non-target species could be affected.

Biological Control – An alternative to chemical treatment, use of biological controls for purple loosestrife should be considered provided site conditions are appropriate to support and maintain the insect

population. Through this method, host-specific insects (one a root infesting weevil; others are leaf-eating chrysomelid beetles) are released to feed on the roots or leaves of purple loosestrife. If purple loosestrife becomes abundant, biological control can prove a cost-effective means of management.

Section VII (d) — Stormwater Best Management Practices

The landscape treatments and systems recommended within this document will require certain management and maintenance activities in order to assure their long-term performance. By making a commitment to regular management and maintenance, individual property owners will be able to:

1. Achieve the desired design results.
2. Prolong the optimal function of landscape designs and treatments.
3. Avoid significant repair and restoration costs.
4. Maintain the aesthetic qualities of the overall landscape.

The following regular activities should be considered as part of the standard management protocols for recommended landscape features:

Vegetated Swales:

Annually:

- Burn or mow.
- Replant sparsely growing areas.
- Repair eroded slopes or bottom.
- Disk or aerate of swale bottom.

Five Year Cycle or As Needed:

- Re-grade and remove sediment to establish original cross-section.
- Replant to restore groundcover.

Bioretention:

Annually or as Needed:

- Repair eroded areas.
- Check mulch and add as needed to maintain 2 to 3 inches of depth.
- Remove and replace all dead or diseased plants.

Permeable Pavers:

Weekly – Sweep or clean surface to remove accumulated dirt or debris.

Monthly – Mechanically remove any vegetation establishing in gravel spaces.

Five to Ten Year Cycle or as Needed – Remove, clean and replace aggregate between pavers.

Stormwater Wetland:

Annually:

- Burn sideslopes initially on an annual basis, then every other year once established.

- Monitor the establishment of native wetland and prairie vegetation until prescribed levels of growth are achieved; replant as necessary for long-term viability and sustainability.
- Treat or remove invasive vegetation.

- Monitor and repair under cut or eroded slopes and damaged embankments.
- Inspect and repair water level control structures.
- Clean out inlet and outlet devices.

Five Year Cycle or As Needed – Remove sediment accumulated in forebays and settling areas every five years or as needed.

Vegetated Filter Strips:

Annually:

- Burn or mow.
- Remove litter or debris.
- Aerate soil biannually.
- Repair eroded areas.
- Replant sparsely vegetated areas.

Section VIII RESOURCES

How to Get Started:

Early contact with the City's Department of Planning and Development is strongly encouraged. Staff is prepared to help smooth the planning and approval process for businesses in the Calumet Area.

To begin, call DPD's industrial division at (312) 744-2214. DPD has two other documents pertinent to business in the Calumet Area that are available from DPD by calling (312) 744- 5528:

Calumet Area Land Use Plan (January 2002)

Calumet Open Space Reserve Plan (2003)

Financial Information:

The City of Chicago's Department of Planning and Development's Finance Division should be contacted early to determine eligibility for financial assistance. In addition to helping you qualify and apply for financial incentives run by the City, planners in this department direct you to the right people to contact for State assistance.

Tax breaks and financial incentives mentioned in this document are described in much greater detail in the DPD publication *Financial Assistance for Business* (Revised April 5, 2002.) This is available from DPD's Finance Division at (312) 744-4389.

Acknowledgments:

Prime Consultant:

Planning Resources Inc. 402 W. Liberty Drive, Wheaton, IL 60187.

Hydrology: Kabbes Engineering Inc. 1250 s. Grove Avenue, Suite 105, Barrington, IL 60010

Soils: Christopher B. Burke Engineering LTD. 9575 W. Higgins Road, Suite 600, Rosemont, IL 60018

Editor: Jill Riddell 4730 S. Kimbark Ave. Chicago, IL 60615

Section IX PRESENTATION GRAPHICS



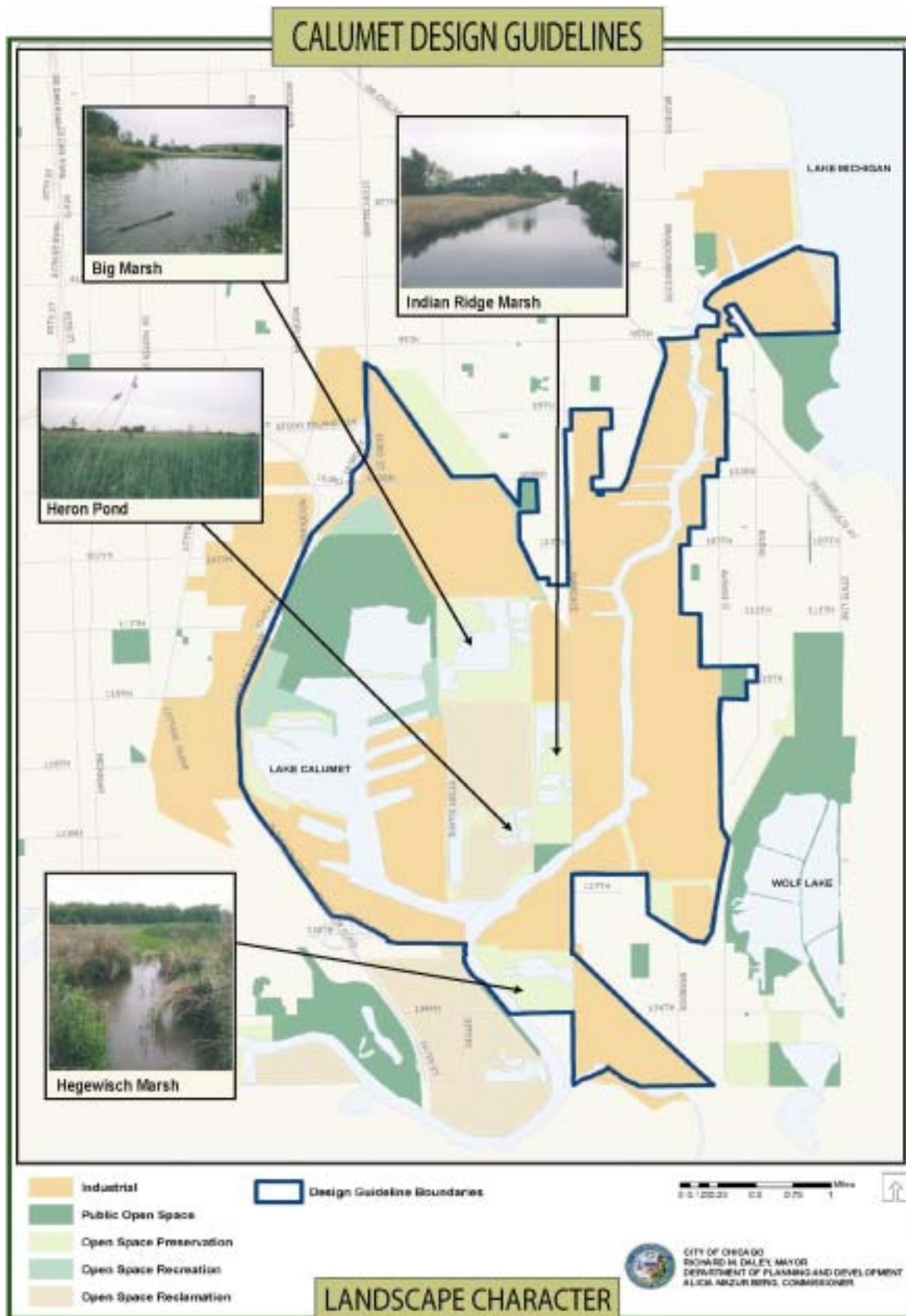

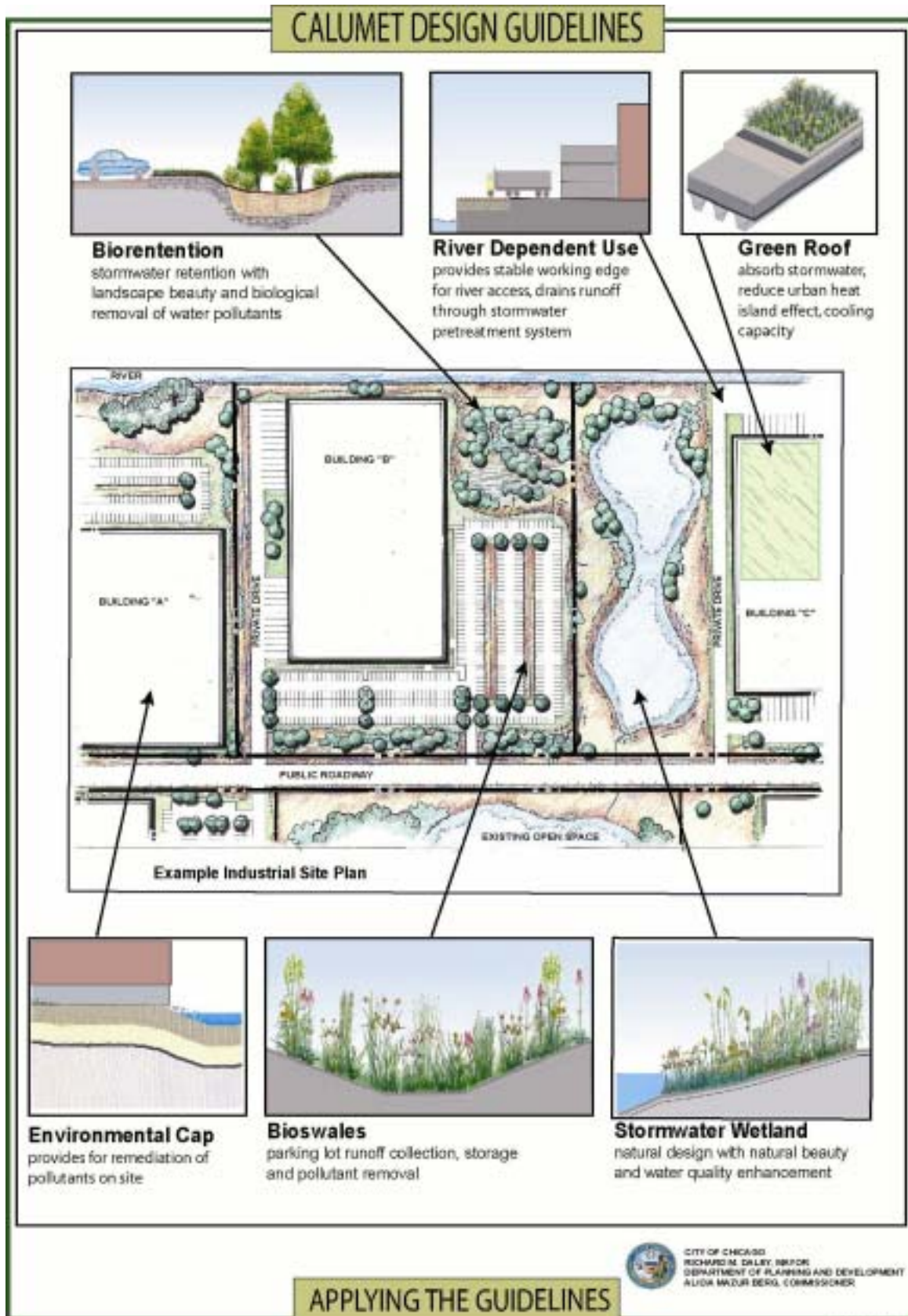

CALUMET DESIGN GUIDELINES



Stormwater Retention - Wetlands



Perimeter Landscaping Adjacent to Buildings



Perimeter Landscaping along Public Streets



Parking Lot Bioswales



CITY OF CHICAGO
RICHARD M. DALEY, MAYOR
DEPARTMENT OF PLANNING AND DEVELOPMENT
ALEXIA MALTUS BERTS, COMMISSIONER

NATURE AS AN INDUSTRIAL NEIGHBOR

April 2, 2010/000000000000